

BEVERAGE & CO2 COMPLETE OFFERING

Parts for installs and repairs.



**EXPLORE OUR EXTENSIVE
BEVERAGE OFFERING**

RELIABLY EVERYWHERE. COMMITTED TO SERVING YOU.

7 AM TO 8 PM EST CUSTOMER SERVICE

Monday through Friday. Live in-person 7 AM EST - 8 PM EST. Ship same day up to 8 PM EST.

sales@rmimfg.com 1-800-264-7793

SAME DAY SHIPPING UP TO 8 PM EST

Strategic warehouse locations around the country. Tennessee, Texas, and California. Over 30,000 products!

reliable delivery.

SHOP 24/7 ONLINE - RMIORDER.COM

Your one-stop shop for all things Ratermann, save your favorites, and review orders.

reliably
RATERMANN



THANK YOU FOR YOUR SUPPORT

At Ratermann we are always striving to be a trusted partner in your business. We hand selected these products to showcase our extensive offering.

Brent Lockhart - President



DEDICATED TO SERVE YOU.

I am here to serve as your go-to point of contact, offering comprehensive assistance and expertise in everything related to beverages and CO2, ensuring your needs are addressed with the utmost care.

Josh Drury - National Sales
Manager Beverage



**SIX SHIPPING LOCATIONS
AROUND THE COUNTRY**

1.800.264.7793 SALES@RMIMFG.COM RMIORDER.COM



WINTER 2024 SALES FLYER

RELIABLE PEOPLE

Meet Josh Drury, the newest addition to our team as the National Sales Manager for Beverage. With many years of experience in the beverage industry, Josh brings a wealth of knowledge and expertise to our organization.

A dedicated Beverage and CO2 Account Manager like Josh can bring a number of benefits to our customers.

Firstly, having a dedicated point of contact for all their needs means that customers can rely on a consistent level of service and support. Josh will be able to understand their specific requirements and tailor our products and services to meet those needs.

Additionally, Josh extensive experience in the beverage industry means that he has a deep understanding of the challenges and opportunities that come with the industry. He is able to anticipate potential issues and proactively work with our customers to find solutions. This helps to ensure that there are minimal disruptions to our customers' operations and that they are able to meet their own production and delivery deadlines.

Furthermore, Josh's role as the CO2 Account Manager ensures that our customers will have a reliable supply of CO2 & beverage products, which is essential. He will be able to work with our customers to ensure they have the right amount of stock at all times, thus reducing any delay in production.

Finally, Josh's expertise in logistics and supply chain management means that he will be able to work with our customers to optimize their operations and minimize costs. By constantly looking for ways to improve efficiency, Josh can help our customers to increase their bottom line.

All of this means that having a dedicated Beverage and CO2 Account Manager like Josh Crambes allows our customers to focus on their core business, knowing that their beverage and CO2 needs are being taken care of by a highly experienced and professional team.



JOSH DRURY

National Sales Manager - Beverage

Email: josh@rmimfg.com

Phone: 562-980-6107



BEVERAGE, BREW & CARBON DIOXIDE

RATERMANN BEVERAGE

Products & Parts

INDEX

Changeovers & Manifolds

Automatic Changeover – CO2 & Inert.....	BEV-21
Automatic Changeover Manifold	BEV-20
Semi-Automatic Switchover Manifold	BEV-22

Fittings

Stainless Steel Hose Barb	BEV-15
Push-in Tube Fittings	BEV-14,17
Stepless Clamps.....	BEV-17

Hoses & Piping

Brass Check Valve	BEV-17
Cryo Bulk Hose Fittings	BEV 37-40
Tubing – Soda Related	BEV-13
Low-Temp Pigtaills.....	BEV-18
Composite Pipe for CO2 Products – 1/2", 3/4" and 1" I.D.	BEV 11-12
Fill Boxes	BEV-44
CO2 Transfer Hoses.....	BEV-19
CO2 Pump	BEV-19

Regulators & Valves

Ball Valves.....	BEV-20
CO2 GSV Series Cylinder Valves	BEV-27
Low Pressure Changeover	BEV-24
Nitrogen Beer Regulator	BEV-25
Soda Regulator	BEV-25
Secondary Regulators.....	BEV-26

Safety Alarm & Monitor

Oxygen Depletion Alarm.....	BEV-46
CO2 Storage Alarm Monitor ..	BEV-47



Beverage Carbonation Systems
see page BEV 5-9



CGA 320 CO2 Cylinder Valves
see page BEV-27

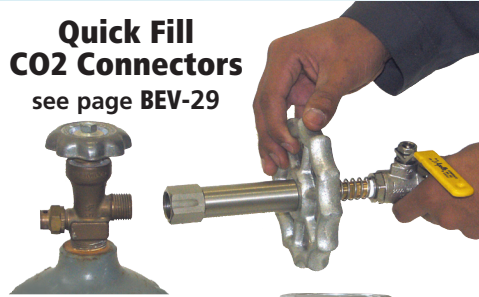

Quick Fill CO2 Connectors
see page BEV-29



Tamper Evident CGA-320 Dust Cover
see page BEV-36



Semi-Automatic Switchover Manifold
see page BEV-22

CO2 Thermoplastic Low-Temp Pigtaills
see page BEV-18

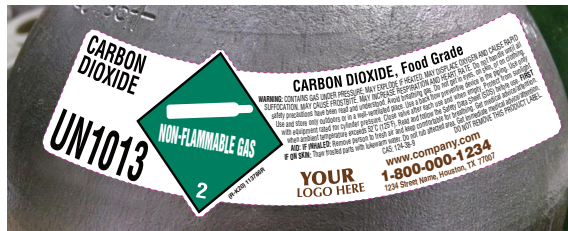

CO2 Cylinder Shoulder Labels
see page BEV-30

IDEAL FOR DISPENSING CARBONATED SOFT DRINKS, BEERS, LAGERS AND OTHER BEVERAGES.

CO2 & Aluminum Industrial Cylinders
see page BEV 41-42



Gauges
see page BEV-35



CGA 320 Valve Protectors
see page BEV-31



Fill Boxes
see page BEV-44

Automatic Changeover Manifold
see page BEV-20



THE PERFORMANCE OF PLASTIC WITH THE STRENGTH OF METAL

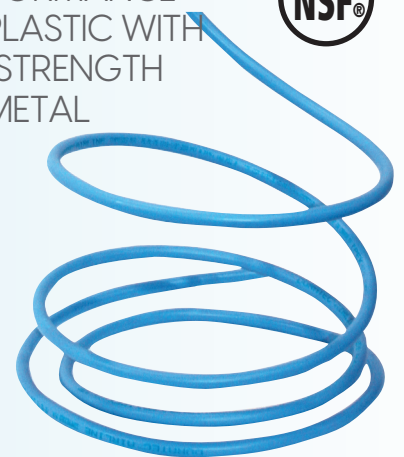

CO2 Composite Piping
see page BEV 11-12

R



A LINCOLN ELECTRIC COMPANY

BEVERAGE REGULATORS

- Part # BEV-RG320-60B
- CGA 320 (CO2) Inlet 0-50 PSI
- Contents Gauge: 0-2000 psi
- Delivery Gauge: 0-60 psi
- Outlet Shutoff Valve Included
- Outlet Fitting: 5/16" Barb
- 5 Year Warranty

reliably
RATERMANN



Josh Drury
National Sales Manager - Beverage



Complete Beverage Catalog

Everything you need for beverage & CO2. Same day shipping on in-stock items.

BEVERAGE CARBONATION SYSTEMS easyCarb 300, 550, 750 HF, & 1000



ONLY EASYCARB OFFERS:

- Newly Designed Faster Fill System – More Customer Deliveries per Day
- Greater Continuous and Peak Flow Rates – 100% Stainless Steel Beverage Vaporizer Coil
- Most Reliable Automatic Fill Shut Off – Designed and Vetted by Industry Experts
- Improved Labeling and Component Identification
- Color Coded Pressure Gauges Highlighting Operating Ranges
- **Newly Designed V-Shaped Legs and Removable Shipping Ring**
- Reconfigured User-Friendly Robust Plumbing Components
- Better Thermal Performance – Longer Product Hold Times, Less Venting



Valuable options to customize your tanks!

- All models available with 6-inch legs
- *Optional* Vent Fill feature available for all models
- *Optional* 120 volt and 240 volt electrical heaters available on EC550 models
- 120 volt adds 20 lbs/hr continuous flow
- 240 volt adds 40 lbs/hr continuous flow

easyCarb 300, 550, 750 HF, 1000 Specifications



		Part Number Model	TWBC-300 EC300	TWBC-550 EC550	TWBC-HF750 EC750 HF	TWBC-1000 EC1000
Dimension						
Diameter	in. (mm)		20 (508)	22 (559)	26 (660)	30 (762)
Height	in. (mm)		49.4 (1255)	68.2 (1733)	70.5 (1791)	73.25 (1860)
Height with legs	in. (mm)		53.6 (1361)	72.4 (1838)	74.0 (1874)	N/A
Weight						
Empty lbs. (kg) (Nominal)			260 (117.93Kg)	392 (178Kg)	410 (181.44Kg)	772 (350Kg)
Capacity						
Gross Volume	gal (liter)		34 (129)	65 (247)	93 (351)	127 (480)
Net Storage Volume	gal (liter)		32 (121)	61 (230)	83 (316)	118 (447)
Liquid lbs. (kg) CO2 Saturated @ 125 psig (8.6 bar)			301 (137)	575 (261)	789 (358)	1000 (453)
Liquid lbs. (kg) CO2 Saturated @ 300 psig (20 bar)			279 (127)	522 (237)	717 (325)	925 (419)
Flow Rates						
Peak Demand	lb/hr (kg/hr)		5.0 (2.3)	20.0 (9.0)	40 (18.0)	30 (14)
Continuous	lb/hr (kg/hr)		2.0 (0.9)	10.0 (4.5)	15.0 (6.8)	50 (23)
Minimum Usage (no venting)						
Liquid	lb/day (kg/day)		2.5 (1.13)	2.9 (1.32)	3.0 (1.4)	3.0 (1.4)
Pressure Building System						
Standard Operating Pressure	psig (bar)		130 psig (8.96)	130 psig (8.96)	N/A	130 (8.96)
Economizer Circuit System						
Standard Operating Pressure	psig (bar)		N/A	N/A	155 (10.34)	155 (10.69)
Safety Device Setting						
Primary Relief Valve	psig (bar)		300 (20.7)	300 (20.7)	300 (20.7)	300 (20.7)
Secondary Relief Valve	psig (bar)		330 (22.75)	330 (22.75)	330 (22.75)	330 (22.75)

⚠ WARNING: Products in this catalog can expose you to chemicals including lead which is known to the State of California to cause cancer, birth defects or reproductive harm. For more information, go to <https://www.p65warnings.ca.gov>

reliably **RATERMANN** BEVERAGE CARBONATION TANKS



REDESIGNED



TESTED



SUPPORTED

CO2 TANKS FOR BEVERAGE CARBONATIONS

Ratermann Manufacturing, Inc. is excited to introduce a full line of beverage carbonation tanks for CO2. Like all of the products we carry, our tanks are backed by our **reliable service**. We want to provide you with a package you can feel 100% confident in.

TESTED AND SUPPORTED

At Ratermann, we provide a guaranteed quality control system that double checks every outgoing order. We fill test and NER test each easyCarb tank before it is shipped to ensure you are receiving a quality product.



For More Information on our easyCarb Tanks please give us a call at 1.800.264.7793
RMIORDER.COM

Ratermann's live support team is available to assist you with any questions or needs before, during and after your buying process.

QUALITY YOU CAN COUNT ON

"Our responsibility is to supply our customers with a bev-carb package that they can feel 100% confident in; a package that will work as it is designed. We want our customers to know our support doesn't stop after the tank is sold, our support is always there for them."

- Brent Lockhart
president

www.rmiororder.com sales@rmimfg.com 1.800.264.7793

TELEMETRY BUILT INTO THE TANK.

reliably
RATERMANN

Beverage Carbonation

easyCarb Tanks

300, 550, 750 HF, 1000
TWBC-300 TWBC-550 TWBC-HF750 TWBC-1000

Josh Drury

National Sales Manager - Beverage

562-980-6107

josh@rmimfg.com

www.rmiororder.com

Want to learn about
beverage telemetry?

Give us a call today!
1-800-264-7793



THE SAFE, NATURAL ALTERNATIVE TO ACID FOR AQUATIC APPLICATIONS

NOVO Bulk CO₂



CO₂ Tank Specifications

reliably
RATERMANN

Part Number
TWBC-750SBR-QF-HTR-P
Model
NOVO 750*

Dimension		
Diameter	in. (mm)	26 (660)
Height	in. (mm)	70.5 (1791)
Weight, Empty	lbs. (kg)	348 (158)
Capacity. CO ₂ - Saturated @ 125 psig (8.6 bar/862 kPa)		
Liquid	lbs. (kg)	789 (358)
Gaseous	cu. ft. (cu. m) @ NTP (STP)	6,897 (182)
Gaseous Flow Rates		
Gaseous Flow Rates	lbs per hour (kg)	20 (9)
Minimum Usage (no venting)		
Liquid	lb. (kg)	3.0 (1.4)
Gaseous	cu. ft. (cu. m.) @ NTP (STP)	28.0 (0.7)
Safety Device Settings (All models)		
Inner Container Relief Valve	psig (bar / kPa)	283 (19.5 / 195)
Fill Line Pressure Relief Valve	psig (bar / kPa)	400 (28 / 2758)
Inner Container Safety Head	psig (bar / kPa)	375 (25.9 / 2586)
Electrical Requirements (NOVO models Only)		
Heater Voltage / Current	VAC / amperes	120 / 7.5
Optional	VAC / amperes	240 / 3.75

* Units available in both electric and non-electric. All electrical components used are NEMA and UL approved. Specifications may vary very slightly for each model and are subject to change without notice.

Control pH with Carbon Dioxide

- No Dangerous Acid Fumes
- Helps Prevent Equipment Damage Due to Acid Corrosion
- Maintain Total Alkalinity without Manually Feeding Chemicals
- New QuickFill Venturi Fill System Eliminates Over or Under Filling and Accelerates the Fill Process
- Maintenance Free Tank Design



⚠ WARNING: Products in this catalog can expose you to chemicals including lead which is known to the State of California to cause cancer, birth defects or reproductive harm. For more information, go to <https://www.p65warnings.ca.gov>

CO₂

It's as Easy as...1,2,3...

One...

CO₂ is inexpensive and readily available. The aquatic industry is seeing a rapidly accelerating trend towards the use of CO₂. It's a cost effective replacement to reduce or replace muriatic acid at your pool.

Two...

The NOVO® cylinders make your water safer for bathers, less damaging to your equipment and minimizes the danger involved with the storage of handling acids as well.

Three...

Our unit is permanently installed. No need to move or change out tanks. It can also do the job of eight or more high pressure cylinders. Connects to your automated pool water controller so that the pH and Total Alkalinity (TA) level you selected are maintained.

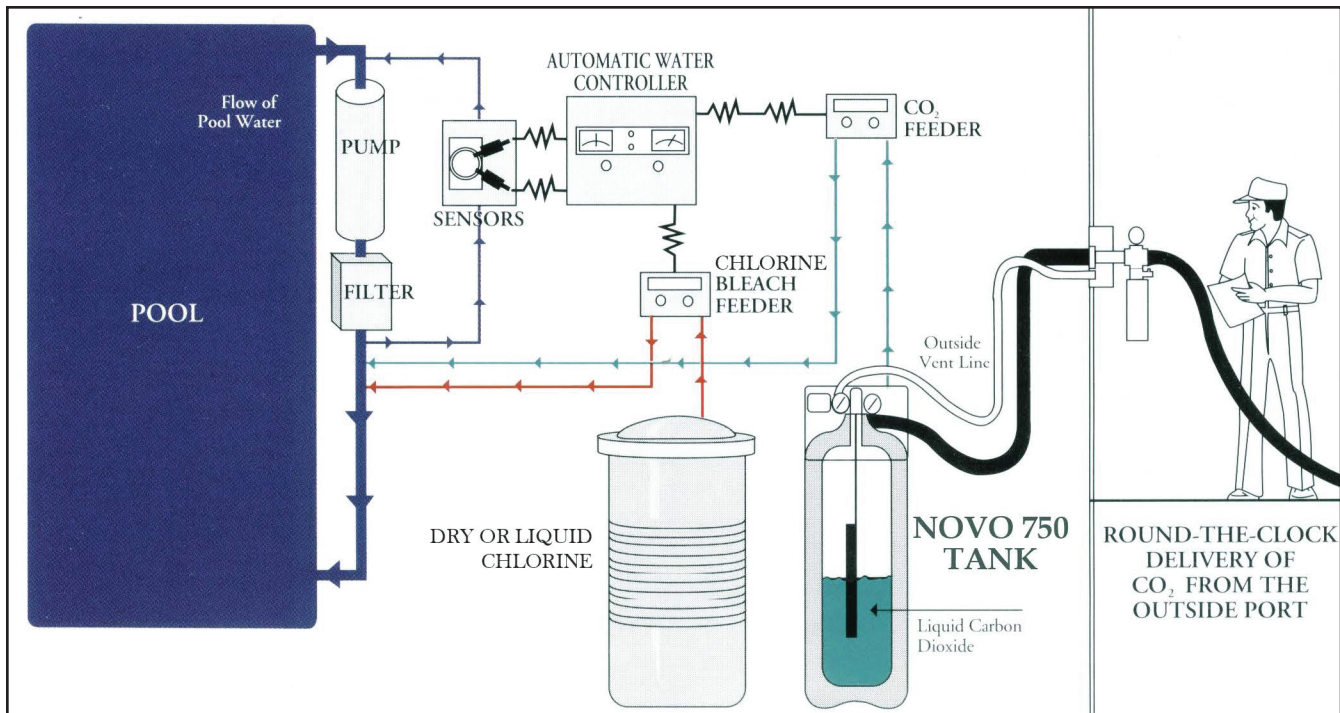
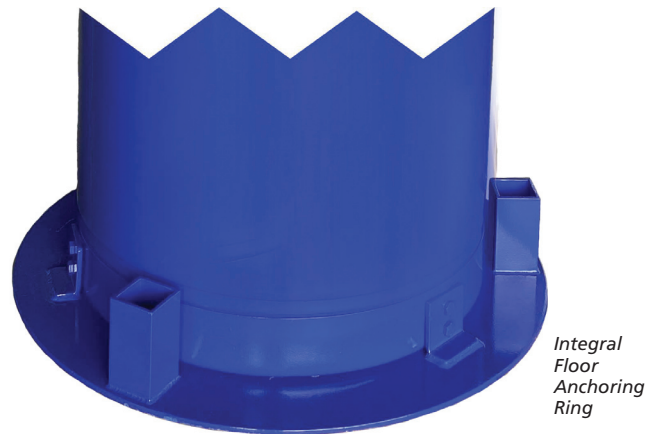
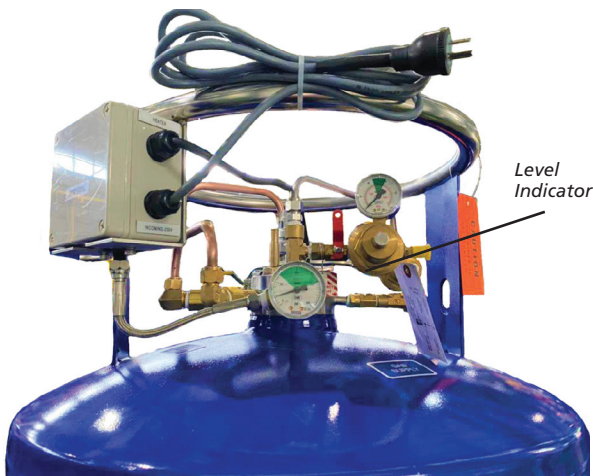

RELIABLY EVERYWHERE.



7 AM EST TO 8 PM EST CUSTOMER SERVICE

Monday through Friday. Live in-person 7 AM EST - 8 PM EST. Ship same day up to 8 PM EST.

SAME DAY SHIPPING UP TO 8PM EST

Strategic warehouse locations around the country. Tennessee, Texas, and California. Over 30,000 products!

SHOP 24/7 ONLINE RMIORDER.COM

Over 30,000 products for the compressed gas & cryogenic industries.

We have you covered.

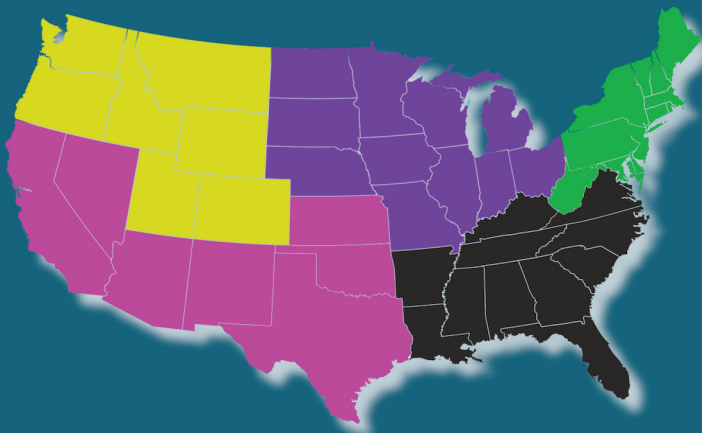

RATERMANN



Heather Schmidt
Account Manager - South East
heather@rmimfg.com



Devon Goodman
Account Manager - North East
devon@rmimfg.com



Greg Richardson
Account Manager - West Coast
greg@rmimfg.com



Chad Goodwin
Account Manager - Midwest
chad@rmimfg.com



Brady Melo
Account Manager - West / Southwest
brady@rmimfg.com



Craig Pagano
National Sales Manager - Industrial
craig@rmimfg.com



George Ratermann
CEO



Brent Lockhart
President



Steve Byers
Vice President



Adam Marcum
National Service Manager



Michael Crambes
Director of Customer Experience



Shari Spain
Inside Sales - Cryogenics



Marie Williams
Director of Business Development



Madeline Westerhoff
Inside Sales - Industrial



Josh Drury
National Sales Manager - Beverage



Tina Rose
Customer Service Manager



Eric Mensik
Account Manager - Cryogenics



Lance Looper
National Sales Manager - Cryogenics



Angel Lopez
National Warehouse Manager

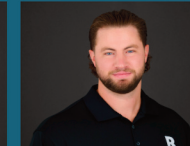

Jake Williams
Marketing Manager



RATERMANN

1.800.264.7793

rmioorder.com

sales@rmimfg.com

CARBON DIOXIDE PRODUCTS Composite Piping

Duratec is an innovative compressed air and inert gas distribution system ideally suited for the demanding food and beverage industry and hospitality sector. Meeting NSF and FDA requirements, Duratec is a completely clean pipe and fitting system. Designed to be absolutely leak-proof, installed quickly and easily, and maintained cost effectively, Duratec saves you time and money.

Traditional metallic compressed air and inert gas systems are a main cause of unnecessary energy use and excessive wear and tear on equipment. The culprits? Corrosion and leakage at pipe joints and fitting connections which often go undetected until they're discovered during a detailed system audit.

Engineered to outperform traditional metal piping systems, Duratec pipe comes in long 100 foot or 300 foot coils, which significantly reduces the number of joints in your system. The Duratec system is secured with durable nickel-plated brass and stainless steel adapter fittings. All fittings feature double o-ring seals to ensure long term joint integrity.

Applications

- Inert Gas Distribution
- CO2 Distribution
- Microbulk Inert Gas Delivery Systems
- Plant Air
- Valve Actuation – Control Systems

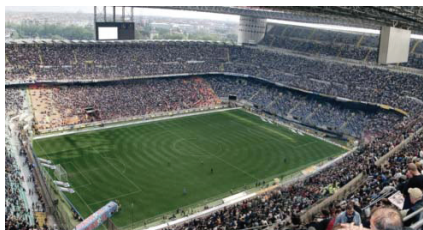

Duratec Installation Tools

- Plastic Pipe Cutter
- 5 in 1 Beveling Tool



Part # CMP-PPC

Part # CMP-BT38-1

- 1/2", 3/4" and 1" sizes
- Operating Pressures 200psi at 73°F, 160psi at 140°F

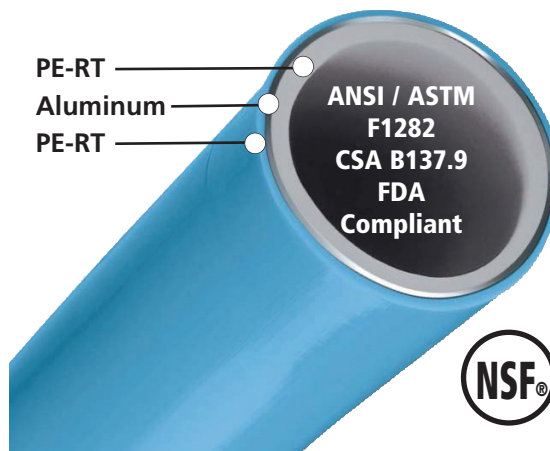

NOTE: 3/8" size Tubing is **Not** PE-RT material and not FDA compliant. 3/8" size is HDPE material.

FEATURES & BENEFITS

Duratec reduces costs on a typical installation not only for materials but also for labour and transportation costs when compared to traditional materials. How? Duratec's lightweight construction and simple assembly procedures which include:

Ease of Handling Duratec is 75% lighter than the equivalent diameter of copper and SCH 40 carbon steel.

Quick Removable Connections Threading is not required. All joints have double o-ring seals and can be quickly assembled or disassembled. Easy on-site modifications and repairs can be made.

Quick Installation No special training or equipment is required to complete a Duratec system.

Fewer Fittings Duratec pipe comes in convenient 100 ft. and 300 ft. coils eliminating several joints and the need for threading, or soldering.

Flexible Yet Rigid Due to its composite structure, Duratec pipe can be easily bent by hand and will maintain its desired shape. This unique feature allows for straight, professional looking installation and eliminates sagging.

LOWER OPERATING COSTS

Due to Duratec's advantages over metal systems, it costs you less time, labour and money to keep a Duratec system in optimal condition.

Pressure loss means money loss Metal systems can lose pressure due to pin-hole leaks and leakage at connections, all of which result in increased energy costs. Duratec's high-quality construction, on the other hand, guarantees consistent pressure for years to come.

Smooth Interior Less friction means lower pressure drops and higher flow rates. This may allow for smaller pipe sizes to be used.

THE PERFORMANCE OF PLASTIC WITH THE STRENGTH OF METAL

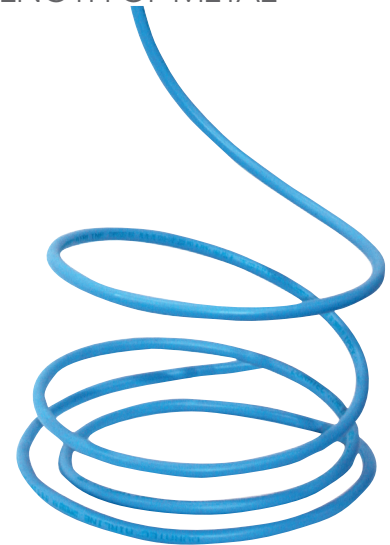

EXTENDED LIFE

Duratec is designed not to rust, scale or pit. Once properly selected for the application and correctly installed, Duratec Airline Systems will provide years of maintenance-free service because they are:

Corrosion Resistant Duratec's tough outer PE-RT (Polyethylene of Raised Temperature) layer protects it against corrosion and deterioration and ensures long service life even in the most aggressive manufacturing environments. Its inner PE-RT layer meets stringent NSF and FDA requirements and is unaffected by inert gases. With a choice of long-lasting nickel-plated brass fittings or 316 stainless steel adapters, the system provides long-term performance superior to traditional metal piping systems.

Clean All Duratec pipe is packaged in cardboard boxes preventing contamination before use. The smooth PE-RT inner layer cannot rust, corrode or form loose scale. Clean air remains clean throughout the life of the system.

Safe Duratec's unique composite construction means that accidental impact or puncture of the pipe results in a safe, ductile mode of failure. Duratec pipe has been third-party tested and certified to stringent OSHA safety requirements, standards that guarantee safety comes first.

Duratec pipe and fittings provide top-notch performance. Rated for long term continuous operating pressures of 200psi at 73°F and 160psi at 140°F, Duratec pipe and fitting assemblies are also capable of sustaining quick burst pressures in excess of 800psi. This built-in safety factor ensures system performance and provides peace of mind for designers and facility managers.

Call or See Main Catalog Section 22A for All Parts & Accessories

WARNING: Products in this catalog can expose you to chemicals including lead which is known to the State of California to cause cancer, birth defects or reproductive harm. For more information, go to <https://www.p65warnings.ca.gov>

Composite Pipe for CO₂, Nitrogen and Argon Gas Working Pressure 200 PSI at 73°



Duratec Airline – Composite Pipe

Part #	Description
CMP-12-100	1/2" x 100 Foot Coil
CMP-12-300	1/2" x 300 Foot Coil
CMP-34-100	3/4" x 100 Foot Coil
CMP-34-300	3/4" x 300 Foot Coil
CMP-1-100	1" x 100 Foot Coil
CMP-1-300	1" x 300 Foot Coil



Duratec Airline –
Adapters
Pipe End x Male Thread Adapter

Part #	Description
CMP-MTA1212	1/2" Pipe x 1/2" MPT
CMP-MTA3434	3/4" Pipe x 3/4" MP
CMP-MTA0101	1" Pipe x 1" MPT



Duratec Airline –
Stainless Steel Adapters
Pipe End x Male Thread Adapter

Part #	Description
CMP-MTASS1212	1/2" Pipe x 1/2" MPT
CMP-MTASS3434	3/4" Pipe x 3/4" MPT
CMP-MTASS0101	1" Pipe x 1" MPT

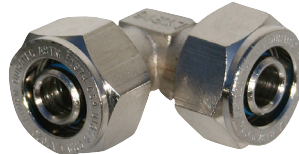

Duratec Airline – 90 Degree Pipe Elbow

Part #	Description
CMP-90E12	1/2" Pipe x 1/2" Pipe
CMP-90E34	3/4" Pipe x 3/4" Pipe
CMP-90E01	1" Pipe x 1" Pipe



Duratec Airline –
Pipe End x Female Thread
90° Wing Back Elbow

Part #	Description
CMP-90EFTWB1212	1/2" Pipe x 1/2" Pipe

Duratec Airline – Wall Bracket Multiport

Part #	Description
CMP-TWBM34F12	3/4" MPT Inlet x 1/2" FPT Outlet

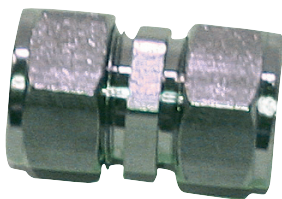

Duratec Airline –
Composite Pipe Coupling

Part #	Description
CMP-C12	1/2"
CMP-C34	3/4"
CMP-C01	1"

Duratec Airline –
Composite Pipe Reducing Coupling

Part #	Description
CMP-RC3412	3/4" x 1/2"
CMP-RT0134	1" x 3/4"

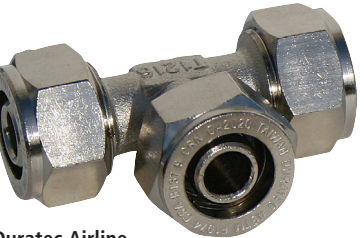

Duratec Airline –
Composite Pipe All Around Pipe Tee

Part #	Description
CMP-TEE12	1/2" x 1/2" x 1/2"
CMP-TEE34	3/4" x 3/4" x 3/4"
CMP-TEE01	1" x 1" x 1"

Duratec Airline –
Composite Pipe Reducing Tee

Part #	Description
CMP-RT341212	3/4" x 1/2" x 1/2"
CMP-RT343412	3/4" x 3/4" x 1/2"
CMP-RT341234	3/4" x 1/2" x 3/4"
CMP-RT010112	1" x 1" x 1/2"
CMP-RT013434	1" x 3/4" x 3/4"
CMP-RT010134	1" x 1" x 3/4"

**Call or See Main Catalog Section 22A
for All Parts & Accessories**

Duratec Airline –
Composite Pipe Caps

Part #	Description
CMP-CAP12	1/2"
CMP-CAP34	3/4"
CMP-CAP01	1"

WARNING: Products in this catalog can expose you to chemicals including lead which is known to the State of California to cause cancer, birth defects or reproductive harm. For more information, go to <https://www.p65warnings.ca.gov>

Food Grade LCO2 Transfer Hose for CO2 & Beverage Applications NSF 51 Rated



RATERMANN'S LCO2 compatible hose will help you meet your **FOOD SAFETY MODERNIZATION ACT (FSMA)** requirements.

Our thermoplastic hose is specially designed for the transfer of liquid and gaseous carbon dioxide (CO2) for beverage applications. It is commonly used on small bulk delivery trucks as well as flexible lines from the restaurant wall-box to the liquid cylinders. The hose is specially formulated to perform well in temperatures as low as -40°F, and the proprietary core tube is plasticizer free and FDA compliant. Our unique bonding process guarantees excellent kink resistance, and the proprietary "Tuff-Skin" cover provides for superior handling and abrasion resistance.

Specifications

Nominal I.D.:	Maximum Working Pressure:
1/2 inch	2,000 PSI
13 mm	138 bar
Maximum O.D.:	Weight:
0.810 inches	lbs. per 100 ft = 14.8
20 mm	kg per 100 m = 22.0
Minimum Bend Radius:	
3.0 inches	
76 mm	

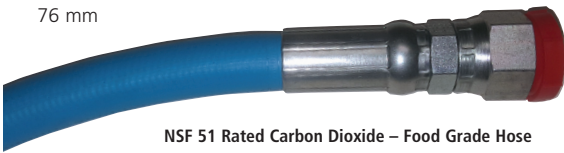

NSF 51 Rated Carbon Dioxide – Food Grade Hose
Pt # BEV-F-

Part #	Description
BEV-F-250R	1/2" ID Food Grade Hose 250 feet
BEV-F-1200FJIC58	1/2" ID Food Grade Hose 100 ft. 5/8 Female JIC Ends
BEV-F-900FJIC58	1/2" ID Food Grade Hose 75 ft. 5/8 Female JIC Ends
BEV-F-780FJIC58	1/2" ID Food Grade Hose 65 ft. 5/8 Female JIC Ends
BEV-F-600FJIC58	1/2" ID Food Grade Hose 50 ft. 5/8 Female JIC Ends
BEV-F-1200M12	1/2" ID Food Grade Hose 100 ft. 1/2 Male NPT Ends
BEV-F-900M12	1/2" ID Food Grade Hose 75 ft. 1/2 Male NPT Ends
BEV-F-780M12	1/2" ID Food Grade Hose 65 ft. 1/2 Male NPT Ends
BEV-F-600M12	1/2" ID Food Grade Hose 50 ft. 1/2 Male NPT Ends



NSF 51 Rated Carbon Dioxide – Food Grade Hose with Vent Tube
Pt # BEV-F-VT

Part #	Description
BEV-F-VT360FJIC58	1/2" ID Food Grade Hose 30 ft. 5/8" F JIC Ends with Vent Tube
BEV-F-VT300FJIC58	1/2" ID Food Grade Hose 25 ft. 5/8" F JIC Ends with Vent Tube
BEV-F-VT180FJIC58	1/2" ID Food Grade Hose 15 ft. 5/8" F JIC Ends with Vent Tube
BEV-F-VT120FJIC58	1/2" ID Food Grade Hose 10 ft. 5/8" F JIC Ends with Vent Tube
BEV-F-VT60FJIC58	1/2" ID Food Grade Hose 5 ft. 5/8" F JIC Ends with Vent Tube

⚠ WARNING: Products in this catalog can expose you to chemicals including lead which is known to the State of California to cause cancer, birth defects or reproductive harm. For more information, go to <https://www.p65warnings.ca.gov>

Polyethylene Beverage Hose

NSF-51 listed Polyethylene reinforced tube, with EVA Copolymer Cover



NSF-51

Ideal for Product Lines

Polyethylene Beverage Hose

Part #	I.D.	Working Pressure at 70° F	Roll Size
BVT-P14-500	1/4"	300 PSI	500'
BVT-P38-300	3/8"	300 PSI	300'
BVT-P12-300	1/2"	250 PSI	300'

UV Stabilized Polyethylene Beverage Hose

NSF-51 listed materials, Specially formulated for superior UV resistance to microbial growth in outdoor or direct sunlight installations.



NSF-51

Reduce Microbial and Algae growth

UV Stabilized Polyethylene Beverage Hose

Part #	I.D.	Working Pressure at 70° F	Roll Size
BVT-PXUV14-500	1/4"	300 PSI	500'
BVT-PXUV38-300	3/8"	300 PSI	300'
BVT-PXUV12-300	1/2"	250 PSI	300'

UV Resistant Polyethylene Beverage Hose

NSF-51 listed, Barrier protected hose provides optimum in UV and weather resistance



NSF-51

Outdoor Gas / Beverage Line

UV Resistant Polyethylene Beverage Hose

Part #	I.D.	Working Pressure at 70° F	Roll Size
BVT-PUV14-500	1/4"	300 PSI	500'
BVT-PUV38-300	3/8"	300 PSI	300'

Precision Cutter

- Saves time cutting tubes and hoses
- Special V-block ensures straight clean cut
- Cuts 1/4" to over 1" OD
- Even cuts Kevlar Lined Hoses.

Part #	Description
BVT-CUTTER	Precision Tube Cutter
BVT-CUTTER-RB	Replacement Blade
BVT-CUTTER-HLST	Belt Holster for Cutter



Push-In Tube Fittings

PROVIDES QUICK & CONVENIENT ASSEMBLY

Products are manufactured from safe, non-toxic materials meeting the requirements of the US FDA, ANSI/NSF-51, 61, and SK Zert.

Do not use this product where the ambient temperature or fluid temperature may exceed 180°F.

Maximum operating pressure -40°F to 68°F is 230 PSI / 149°F is 150 PSI.

Fittings listed fit the following tubings:

- 1/4" O.D. fits 08H05-154
- 5/16" O.D. fits 08H05-247
- 3/8" O.D. fits 08H05-115
- 1/2" O.D. fits 08H05-116



ELBOW

Part #	Description
PI-90-OD140D14	1/4" O.D. x 1/4" O.D.
PI-90-OD140D38	1/4" O.D. x 3/8" O.D.
PI-90-OD380D38	3/8" O.D. x 3/8" O.D.
PI-90-OD380D12	3/8" O.D. x 1/2" O.D.
PI-90-OD120D12	1/2" O.D. x 1/2" O.D.



TEE

Part #	Description
PI-TEE-OD14	1/4" O.D. (ALL)
PI-TEE-OD380D140D14	3/8" x 3/8" x 1/4" O.D.
PI-TEE-OD38	3/8" O.D. (ALL)
PI-TEE-OD120D120D38	1/2" x 1/2" x 3/8" O.D.
PI-TEE-OD12	1/2" O.D. (ALL)



PUSH-IN SHUTOFF

Part #	Description
PI-SO-OD14	1/4" O.D.
PI-SO-OD38	3/8" O.D.
PI-SO-OD12	1/2" O.D.



END STOP

Part #	Description
PI-ES-OD14	1/4" O.D.
PI-ES-OD38	3/8" O.D.
PI-ES-OD12	1/2" O.D.



CROSS

Part #	Description
PI-X-OD14	1/4" O.D. (ALL)
PI-X-OD38	3/8" O.D. (ALL)
PI-X-OD12	1/2" O.D. (ALL)



MALE PIPE ADAPTER

Part #	Description
PI-A-M140D14	1/4" MPT x 1/4" O.D.
PI-A-M140D38	1/4" MPT x 3/8" O.D.
PI-A-M380D38	3/8" MPT x 3/8" O.D.
PI-A-M380D12	3/8" MPT x 1/2" O.D.
PI-A-M120D38	1/2" MPT x 3/8" O.D.
PI-A-M120D12	1/2" MPT x 1/2" O.D.



FEMALE PIPE & FEMALE FLARE ADAPTERS

Part #	Description
PI-A-F140D14	1/4" FPT x 1/4" O.D.
PI-A-F140D38	1/4" FPT x 3/8" O.D.
PI-A-FFL140D14	1/4" FFL x 1/4" O.D.
PI-A-FFL140D38	1/4" FFL x 3/8" O.D.
PI-A-FFL380D38	3/8" FFL x 3/8" O.D.



UNION

Part #	Description
PI-U-OD140D14	1/4" O.D. x 1/4" O.D.
PI-U-OD140D38	1/4" O.D. x 3/8" O.D.
PI-U-OD5160D38	5/16" O.D. x 3/8" O.D.
PI-U-OD380D38	3/8" O.D. x 3/8" O.D.
PI-U-OD380D12	3/8" O.D. x 1/2" O.D.
PI-U-OD120D12	1/2" O.D. x 1/2" O.D.



Y

Part #	Description
PI-Y-OD14	1/4" O.D. (ALL)
PI-Y-OD516	5/16" O.D. (ALL)
PI-Y-OD38	3/8" O.D. (ALL)
PI-Y-OD380D120D12	3/8" x 1/2" x 1/2" O.D.
PI-Y-OD12	1/2" O.D. (ALL)



MALE FLARE ADAPTER

Part #	Description
PI-A-MFL140D14	1/4" MFL x 1/4" O.D.
PI-A-MFL140D38	1/4" MFL x 3/8" O.D.
PI-A-MFL5160D38	5/16" MFL x 3/8" O.D.
PI-A-MFL380D38	3/8" MFL x 3/8" O.D.
PI-A-MFL120D12	1/2" MFL x 1/2" O.D.



BULKHEAD ADAPTER

Part #	Description
PI-BHA-OD38	3/8" O.D.
PI-BHA-OD12	1/2" O.D.

CARBON DIOXIDE PRODUCTS Stainless Steel Hose Barb Fittings



STRAIGHT

Part #	Tube I.D. Size
BFTSS-B18B18	1/8"
BFTSS-B18B14	1/8" x 1/4"
BFTSS-B316B316	3/16" x 3/16"
BFTSS-B316B14	3/16" x 1/4"
BFTSS-B316B38	3/16" x 3/8"
BFTSS-B14B14	1/4"
BFTSS-B14B14-TH	1/4" Thinwall
BFTSS-B14B516	1/4" x 5/16"
BFTSS-B14B516-TH	1/4" x 5/16" Thinwall
BFTSS-B14B12	1/4" x 1/2"
BFTSS-B14B12-TH	1/4" x 1/2" Thinwall
BFTSS-B516B516	5/16"
BFTSS-B516B38	5/16" x 3/8"
BFTSS-B14B38	1/4" x 3/8"
BFTSS-B14B38-TH	1/4" x 3/8" Thinwall
BFTSS-B38B38	3/8"
BFTSS-B38B38-TH	3/8" Thinwall
BFTSS-B38B12	3/8" x 1/2"
BFTSS-B38B12-TH	3/8" x 1/2" Thinwall
BFTSS-B12B12	1/2"
BFTSS-B12B12-TH	1/2" Thinwall
BFTSS-B34B34	3/4"



U-BEND

Barb to Barb

Part #	Tube I.D. Size
BFTSS-UB14	1/4" Barb A = 1-1/4"
BFTSS-UB14-TH	1/4" Barb Thinwall A = 1"
BFTSS-UB516	5/16" Barbs A = 2"
BFTSS-UB38	3/8" Barbs A = 2"
BFTSS-UB38-TH	3/8" Barbs Thinwall A = 1-1/4"
BFTSS-UB12	1/2" Barbs A = 3"
BFTSS-UB12-TH	1/2" Barbs Thinwall A = 2-1/8"

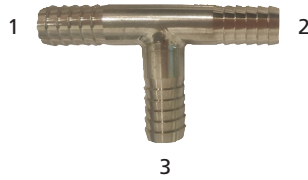

TEE

Part #	Tube I.D. Size
BFTSS-TEEB14	1/4" (ALL)
BFTSS-TEEB14-TH	1/4" (ALL) Thinwall
BFTSS-TEEB14B38	1/4" (1&2) x 3/8" (3)
BFTSS-TEEB14B38-TH	1/4" (1&2) x 3/8" Thinwall
BFTSS-TEEB516B516	5/16" (ALL)
BFTSS-TEEB516B516-TH	5/16" (ALL) Thinwall
BFTSS-TEEB38B14	3/8" (1&2) x 1/4" (3)
BFTSS-TEEB38B14-TH	3/8" (1&2) x 1/4" Thinwall
BFTSS-TEEB38	3/8" (ALL)
BFTSS-TEEB38-TH	3/8" (ALL) Thinwall
BFTSS-TEEB38B12	3/8" (1&2) x 1/2" (3)
BFTSS-TEEB38B12-TH	3/8" (1&2) x 1/2" (3) Thinwall
BFTSS-TEEB12B14	1/2" (1&2) x 1/4" (3)
BFTSS-TEEB12B38	1/2" (1&2) x 3/8" (3)
BFTSS-TEEB12B38-TH	1/2" (1&2) x 3/8" Thinwall
BFTSS-TEEB12	1/2" (ALL)
BFTSS-TEEB12-TH	1/2" (ALL) Thinwall
BFTSS-TEEB34	3/4" (ALL)



U-BEND WITH MANIFOLD

Two Barbs to Barb

Part #	Tube I.D. Size
BFTSS-UMB14BM14	1/4" Barbs x 1/4" Barb Man. A = 1-3/8"
BFTSS-UMB14BM14-TH	1/4" Barbs x 1/4" B Thinwall A = 1"
BFTSS-UMB14BM38	1/4" Barbs x 3/8" Barb Man. A = 1-1/2"
BFTSS-UMB516BM516	5/16" Barbs x 5/16" Barb Man. A = 2-1/4"
BFTSS-UMB38BM14	3/8" Barbs x 1/4" Barb Man. A = 2-1/2"
BFTSS-UMB38BM38	3/8" Barbs x 3/8" Barb Man. A = 1-5/8"
BFTSS-UMB38BM38-TH	3/8" B x 3/8" B Thinwall A = 1-5/8"
BFTSS-UMB38BM12	3/8" Barbs x 1/2" Barb Man. A = 2"
BFTSS-UMB12BM38	1/2" Barbs x 3/8" Barb Man. A = 2-1/4"
BFTSS-UMB12BM12	1/2" Barbs x 1/2" Barb Man. A = 2-1/4"

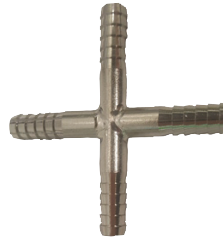

CROSS

Part #	Tube I.D. Size
BFTSS-XB14	1/4"
BFTSS-XB38	3/8"



PLUG

Part #	Tube I.D. Size
BFTSS-PLUGB14	1/4"
BFTSS-PLUGB14-TH	1/4" Thinwall
BFTSS-PLUGB516	5/16"
BFTSS-PLUGB38	3/8"
BFTSS-PLUGB38-TH	3/8" Thinwall
BFTSS-PLUGB12	1/2"

"Y" TEE

90° Leg Angle

Part #	Tube I.D. Size
BFTSS-YTEEB14	1/4" A = 1-1/8"
BFTSS-YTEEB14-TH	1/4" Thinwall A = 1-1/8"
BFTSS-YTEEB38	3/8" A = 11/4"
BFTSS-YTEEB38-TH	3/8" Thinwall A = 1-1/4"



ELBOW

Part #	Tube I.D. Size
BFTSS-90RB14	1/4"
BFTSS-90RB14-TH	1/4" Thinwall
BFTSS-90RB14B516	1/4" x 5/16"
BFTSS-90RB38	3/8"
BFTSS-90RB38-TH	3/8" Thinwall
BFTSS-90RB14B38	1/4" x 3/8"
BFTSS-90RB14B38-TH	1/4" x 3/8" Thinwall
BFTSS-90RB12	1/2"
BFTSS-90RB12-TH	1/2" Thinwall
BFTSS-90RB12B38	1/2" x 3/8"



90° SWIVEL ADAPTER

Barb to Female Flare

Part #	Tube I.D. Size
BFTSS-90B14FLN14	1/4 B to 1/4 FFL
BFTSS-90B14FLN38	1/4 B to 3/8 FFL
BFTSS-90B14FLN12	1/4 B to 1/2-16 FFL
BFTSS-90B38FLN14	3/8 B to 1/4 FFL
BFTSS-90B38FLN38	3/8 B to 3/8 FFL
BFTSS-90B38FLN12	3/8 B to 1/2 FFL
BFTSS-90B12FLN38	1/2 B to 3/8 FFL
BFTSS-90B12FLN12	1/2 B to 1/2 FFL

45° SWIVEL ADAPTER

Barb to Female Flare

Part #	Tube I.D. Size
BFTSS-45B14FLN14	1/4 B to 1/4 FFL

CARBON DIOXIDE PRODUCTS Stainless Steel Hose Barb Fittings



Part # BFT-FS-N14



Part # BFT-FS-BS14

FLARE SWIVEL SETS

Part #	Description
BFT-FS-N14	1/4" Flare Nut
BFT-FS-BS18	1/8" Stem for 1/4" Nut
BFT-FS-BS532	5/32" Stem for 1/4" Nut
BFT-FS-BS14	1/4" Stem for 1/4" Nut

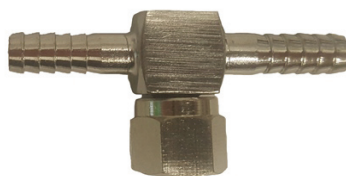

SWIVEL TEE

Part #	Description
BFTSS-TEEB14FLN14	1/4 Barb x 1/4 Flare Swivel



FLARE CAP

Part #	Description
BFT-FCAP14	1/4" Flare Cap



SWIVEL ROUNDED ELBOWS

Part #	Description
BFTSS-90RB14FLN14	90° Elbow 1/4 Barb x 1/4 Flare Swivel
BFTSS-90RB38FLN14	90° Elbow 3/8 Barb x 1/4 Flare Swivel



SWIVEL TEE

Part #	Description
BFTSS-TEEB14FLN14SD	1/4 Barb with 1/4 Side Flare Swivel



ADAPTER

Barb to Male Pipe

Part #	Description
BFTSS-B14M18	1/4 Barb x 1/8 M NPT
BFTSS-B14M14	1/4 Barb x 1/4 M NPT
BFTSS-B14M38	1/4 Barb x 3/8 M NPT
BFTSS-B38M18	3/8 Barb x 1/8 M NPT
BFTSS-B38M14	3/8 Barb x 1/4 M NPT
BFTSS-B38M38	3/8 Barb x 3/8 M NPT
BFTSS-B38M12	3/8 Barb x 1/2 M NPT
BFTSS-B12M14	1/2 Barb x 1/4 M NPT
BFTSS-B12M38	1/2 Barb x 3/8 M NPT
BFTSS-B12M12	1/2 Barb x 1/2 M NPT
BFTSS-B34M34	3/4 Barb x 3/4 M NPT



Part # BFTN-BRN78

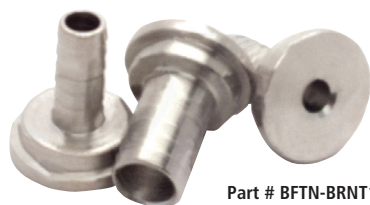

Part # BFTN-BRNT14



90° ELBOW

Barb to Male Pipe

Part #	Description
BFTSS-90B14M18	Elbow, 1/4 Barb x 1/8 M NPT
BFTSS-90B14M14	Elbow, 1/4 Barb x 1/4 M NPT
BFTSS-90B14M38	Elbow, 1/4 Barb x 3/8 M NPT
BFTSS-90B38M14	Elbow, 3/8 Barb x 1/4 M NPT
BFTSS-90B38M38	Elbow, 3/8 Barb x 3/8 M NPT
BFTSS-90B38M12	Elbow, 3/8 Barb x 1/2 M NPT
BFTSS-90B12M12	Elbow, 1/2 Barb x 1/2 M NPT

BEER NUT AND TAILPIECE

Nickle Plated

Part #	Description
BFTN-BRN78	7/8" -14 Hex Beer Nut
BFTN-BRNT14	1/4" Tailpiece for Beer Nut
BFTN-BRNT38	3/8" Tailpiece for Beer Nut
BFTN-BRNT12	1/2" Tailpiece for Beer Nut



NYLON FLARE WASHERS

Part #	Description
BFTSS-GASKFL14-PK25	1/4" Flare Nylon Washer

STEMS FIT INTO OTHER PUSH-IN FITTINGS



MALE PIPE ADAPTER

Part #	Description
PI-A-ST14M14	1/4" Stem x 1/4" MPT
PI-A-ST38M14	3/8" Stem x 1/4" MPT
PI-A-ST38M38	3/8" Stem x 3/8" MPT
PI-A-ST12M38	1/2" Stem x 3/8" MPT
PI-A-ST12M12	1/2" Stem x 1/2" MPT

REDUCER

Part #	Description
PI-R-ST38OD14	3/8" Stem x 1/4" O.D.
PI-R-ST12OD38	1/2" Stem x 3/8" O.D.



ELBOW

Part #	Description
PI-90-ST14OD14	1/4" Stem x 1/4" O.D.
PI-90-ST38OD14	3/8" Stem x 1/4" O.D.
PI-90-ST38OD38	3/8" Stem x 3/8" O.D.
PI-90-ST12OD12	1/2" Stem x 1/2" O.D.

BARBED END ADAPTS BRAIDED TUBING TO BE COMPATIBLE WITH PUSH-IN FITTINGS



STRAIGHT BARB TO STEM

Part #	Description
PI-A-ST14B14	1/4" B x 1/4" Stem
PI-A-ST38B14	1/4" B x 3/8" Stem
PI-A-ST38B516	5/16" B x 3/8" Stem
PI-A-ST516B38	3/8" B x 5/16" Stem
PI-A-ST38B38	3/8" B x 3/8" Stem
PI-A-ST12B38	3/8" B x 1/2" Stem
PI-A-ST38B12	1/2" B x 3/8" Stem
PI-A-ST12B12	1/2" B x 1/2" Stem



ELBOW BARB TO STEM

Part #	Description
PI-90-ST14B14	1/4" B x 1/4" Stem
PI-90-ST38B14	1/4" B x 3/8" Stem
PI-90-ST38B38	3/8" B x 3/8" Stem



CHECK VALVE

Part #	Description
PI-CV-OD14	1/4" O.D. Tube
PI-CV-OD38	3/8" O.D. Tube
PI-CV-OD12	1/2" O.D. Tube



PLUG STEM

Part #	Description
PI-PLUG-ODST14	1/4" O.D. Stem
PI-PLUG-ODST38	3/8" O.D. Stem
PI-PLUG-ODST12	1/2" O.D. Stem



LOCK OUT CLIP

Part #	Description
PI-LOC-OD14	1/4" O.D. Tube
PI-LOC-OD38	3/8" O.D. Tube
PI-LOC-OD12	1/2" O.D. Tube

Stainless Steel Stepless Clamps



- Manufactured of 304 grade stainless steel for extended durability and increased corrosion resistance
- Tongue-in-groove design provides uniform pressure and gapless leak-free seal
- Burr-free edges to protect parts and to prevent injury during assembly
- The clamp ears adjustable crimp range compensates for component tolerances and applied pressure

Stainless Steel Stepless Clamps

Part Number Pack of 25	Range	Clamp Index
CL-SLSS-6.5-PK25	.209 - .256	-
CL-SLSS-7.0-PK25	.228 - .276	-
CL-SLSS-8.0-PK25	.268 - .315	-
CL-SLSS-8.7-PK25	.276 - .343	A
CL-SLSS-9.5-PK25	.307 - .374	-
CL-SLSS-10.0-PK25	.327 - .394	-
CL-SLSS-10.5-PK25	.346 - .413	B
CL-SLSS-11.3-PK25	.378 - .445	D
CL-SLSS-11.8-PK25	.398 - .465	-
CL-SLSS-12.3-PK25	.386 - .484	C
CL-SLSS-13.3-PK25	.425 - .524	E
CL-SLSS-14.0-PK25	.453 - .551	F
CL-SLSS-14.5-PK25	.472 - .571	Q
CL-SLSS-15.3-PK25	.504 - .602	-
CL-SLSS-15.7-PK25	.520 - .618	G
CL-SLSS-16.2-PK25	.539 - .638	M
CL-SLSS-17.0-PK25	.571 - .669	H
CL-SLSS-17.5-PK25	.591 - .689	-
CL-SLSS-18.5-PK25	.602 - .728	J
CL-SLSS-19.8-PK25	.654 - .780	K
CL-SLSS-21.0-PK25	.701 - .827	I
CL-SLSS-22.6-PK25	.764 - .890	L
CL-SLSS-23.5-PK25	.799 - .925	-

SS Stepless Clamps continued

Part Number Pack of 25	Range	Clamp Index
CL-SLSS-24.1-PK25	.823 - .949	-
CL-SLSS-25.6-PK25	.882 - 1.008	-
CL-SLSS-27.1-PK25	.941 - 1.067	-
CL-SLSS-28.6-PK25	1.00 - 1.126	P
CL-SLSS-30.1-PK25	1.06 - 1.185	-
CL-SLSS-31.6-PK25	1.12 - 1.244	-
CL-SLSS-33.1-PK25	1.18 - 1.303	-
CL-SLSS-34.6-PK25	1.24 - 1.362	-
CL-SLSS-36.1-PK25	1.30 - 1.421	-
CL-SLSS-37.6-PK25	1.35 - 1.480	-
CL-SLSS-38.1-PK25	1.37 - 1.500	-
CL-SLSS-39.6-PK25	1.43 - 1.559	-
CL-SLSS-41.0-PK25	1.49 - 1.614	-
CL-SLSS-42.5-PK25	1.55 - 1.673	-
CL-SLSS-44.0-PK25	1.61 - 1.732	-
CL-SLSS-45.5-PK25	1.67 - 1.791	-
CL-SLSS-47.0-PK25	1.72 - 1.850	-
CL-SLSS-48.5-PK25	1.78 - 1.909	-
CL-SLSS-50.0-PK25	1.84 - 1.969	-
CL-SLSS-51.5-PK25	1.90 - 2.028	-
CL-SLSS-52.2-PK25	1.93 - 2.055	-
CL-SLSS-53.0-PK25	1.96 - 2.087	-
CL-SLSS-54.5-PK25	2.02 - 2.146	-
CL-SLSS-56.0-PK25	2.08 - 2.205	-

Brass Check Valve

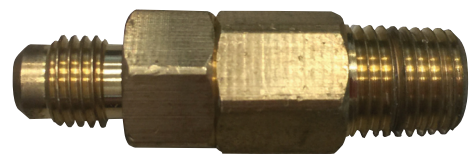

Part #	Description
BFT-CVM14MFL14	Brass Check Valve, 1/4 M NPT x 1/4 M Flare

WARNING: Products in this catalog can expose you to chemicals including lead which is known to the State of California to cause cancer, birth defects or reproductive harm. For more information, go to <https://www.p65warnings.ca.gov>

CO2 THERMOPLASTIC LOW-TEMP PIGTAILS 2,750 PSIG MAWP Rated

Hoses for the Following Gases



2750 PSIG MAWP Rated – Plated Carbon Steel End Fittings

These pigtails are constructed with a Polyester low temperature tube and cover. Each assembly is tested to 1 1/2 times MAWP. Branded with part number, size and MAWP. Meets SAE 100R7 specifications.

Style Specifications

Not recommended for oxygen service. Meets SAE 100R7 specs

Liner: Low temperature Polyester

Reinforcement: Polyester braid

Cover: Pin-pricked Polyester

Temperature: -65° F to +212° F



WARNING: Products in this catalog can expose you to chemicals including Lead which is known to the State of California to cause cancer, birth defects or reproductive harm. For more information, go to <https://www.p65warnings.ca.gov>

Ratermann Mfg. TPL Family of Hoses

Standard Hose without Armor Casing

1/4" NPT Female x 1/4" NPT Female

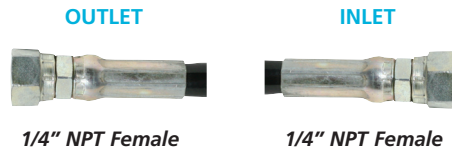

Hose Length	Part #
24"	TPL-24F14
36"	TPL-36F14
48"	TPL-48F14
72"	TPL-72F14

1/4" NPT Female x 1/4" NPT Male

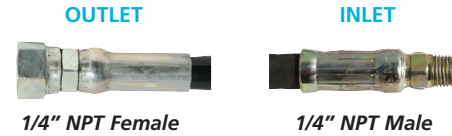

Hose Length	Part #
24"	TPL-24F14M14
36"	TPL-36F14M14
48"	TPL-48F14M14
72"	TPL-72F14M14

1/4" NPT Male x 1/4" NPT Male

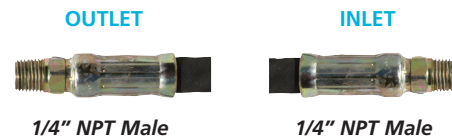

Hose Length	Part #
24"	TPL-24M14
36"	TPL-36M14
48"	TPL-48M14
72"	TPL-72M14

1/4" NPT Female x 1/4" NPT Female JIC 37 Swivel

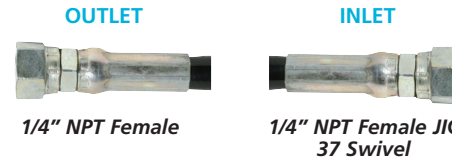

Hose Length	Part #
24"	TPL-24F14FJIC14S
36"	TPL-36F14FJIC14S
48"	TPL-48F14FJIC14S
72"	TPL-72F14FJIC14S

1/4" NPT Male x 1/4" NPT Female JIC 37 Swivel

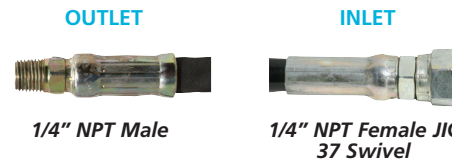

Hose Length	Part #
24"	TPL-24M14FJIC14S
36"	TPL-36M14FJIC14S
48"	TPL-48M14FJIC14S
72"	TPL-72M14FJIC14S

WARNING: Products in this catalog can expose you to chemicals including Lead which is known to the State of California to cause cancer, birth defects or reproductive harm. For more information, go to <https://www.p65warnings.ca.gov>

Fill Gun Quick Connector / Dry Break Wing Nut Style

(Standard Nitrile seals are rated to -40° F. Contact Ratermann for information on parts with special order seals rated below -40° F.)

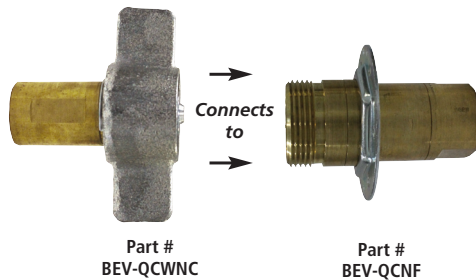

Part #	Description
BEV-QCWNC	CO2 Quick Connect Fill Wing Nut Coupler
BEV-QCNF	CO2 Quick Connect Fill Nipple with Flange

WARNING: Products in this catalog can expose you to chemicals including lead which is known to the State of California to cause cancer, birth defects or reproductive harm. For more information, go to <https://www.p65warnings.ca.gov>

Hose Reel for Thermoplastic Hoses



Part # BEV-REEL

Hose Reel to be Installed on Liquid CO2 Delivery Vehicles

BEV-REEL with 1/2" full-flow Super Swivel with low temp Buna seal and FDA grease. Spring retractable heavy duty painted reel will handle up to 100 feet of 1/2" hose. 2000 PSIG Rated.

CO2 Transfer Hoses 450 PSIG MAWP CO2 Pump



A lightweight, yet durable rubber hose manufactured specially for the demands of Carbon Dioxide

Transfer hoses are manufactured specifically for the demanding requirements of CO2 liquid and vapor transfer. Unlike rubber hydraulic hose that is constructed with carbon steel reinforcing, these hoses are reinforced with stainless steel braids to resist carbonic acid – the result of CO2 and moisture combination. In addition, our pricked cover solves the problem of bubbling that the covers of hydraulic hoses have experienced. These hoses will be dramatically more flexible in CO2 transfer than standard rubber hoses due to a specially blended tube rated to minus 65° F. The two-braid construction also offers much better kink resistance than comparable single braid products.

SPECIFICATIONS

Liquid / Vapor CO2 Transfer Hose

- Tube** Special Neoprene blend rated for -65° F
- Reinforcement** Two stainless steel braids
- Cover** Special Neoprene blend. Black with blue Mylar
- Temperature** -65° F to +180° F
- Pressure Range** 450 PSIG MAWP
- Branding** Blue Mylar
- CGA Fittings** Brass sleeve, nut, and dust caps available
- Other Fittings Available** Female NPT brass bar-stock fitting with aluminum crimp collar

See below to Order Custom Length Hoses

⚠ WARNING: Products in this catalog can expose you to chemicals including Lead which is known to the State of California to cause cancer, birth defects or reproductive harm. For more information, go to <https://www.p65warnings.ca.gov>

Part #	I.D. (In.)	O.D. (In.)	Max WP PSIG	Min Burst PSIG	Weight Per Foot
CTH1	1	1.58	450	2250	0.83
CTH112	1 1/2	2.08	450	2250	1.19
CTH2	2	2.60	450	2250	1.90

CO2 Transfer Hoses – 450 PSIG MAWP

Female NPT x Female NPT

1" I.D. - 1" FNPT x 1" FNPT

Hose Length	Part #
10'	CTH-11D-F1BH120
20'	CTH-11D-F1BH240

1 1/2" I.D. - 1 1/2" FNPT x 1 1/2" FNPT

Hose Length	Part #
10'	CTH-112ID-F112BH120
20'	CTH-112ID-F112BH240

2" I.D. - 2" FNPT x 2" FNPT

Hose Length	Part #
10'	CTH-2ID-F2BH120
20'	CTH-2ID-F2BH240

CO2 Connections

1" Carbon Dioxide Connection

Hose Length	Part #
10'	CTH-11D-CGA320BH120
20'	CTH-11D-CGA320BH240

1 1/2" Carbon Dioxide Connection

Hose Length	Part #
10'	CTH-112ID-CGA320BH120
20'	CTH-112ID-CGA320BH240

2" I.D. - Carbon Dioxide Connection

Hose Length	Part #
10'	CTH-2ID-CGA320BH120
20'	CTH-2ID-CGA320BH240

Carbon Dioxide Hose End Assembly

Part Number	Size
BHEA-CO2-100	1"
BHEA-CO2-150	1 1/2"
BHEA-CO2-200	2"

Complete Unit Includes:

- 1 Dust Plug Assembly
- 2 Head Piece
- 3 Nut

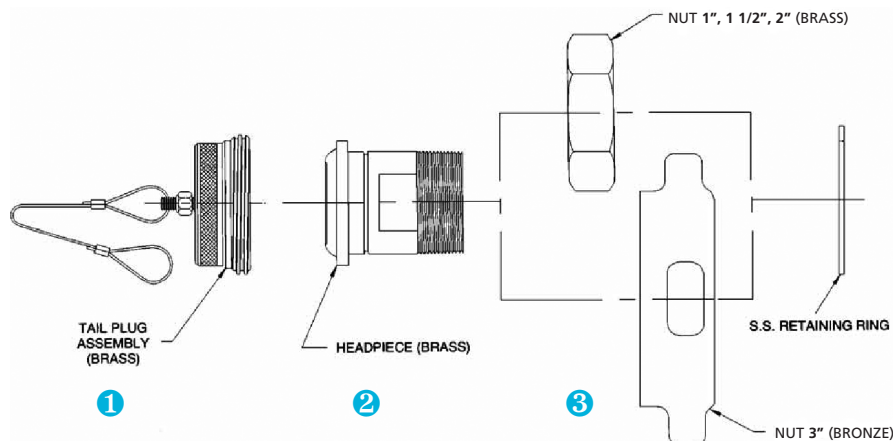

Carbon Dioxide Pump

Positive Displacement Pumps and Oil-Free Gas Compressors for Liquid CO2 Applications

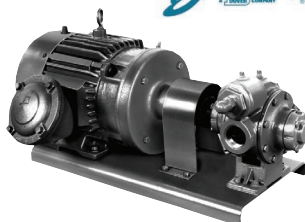

Part # CO2P-114-BPM3H

- Recirculation
- Processing
- Bulk Transfer
- Truck & Transport
- Railcar Unloading
- Vapor Recovery

Carbon Dioxide Pump 1 1/4" on a base plate with Motor.

⚠ WARNING: Products in this catalog can expose you to chemicals including lead which is known to the State of California to cause cancer, birth defects or reproductive harm. For more information, go to <https://www.p65warnings.ca.gov>

Custom Length Hose – CO2 Transfer Hoses

ORDER CUSTOM LENGTH HOSE*

CO2 Transfer Hose

Hose I.D. Size

- Pt # 11"
- Pt # 1121 1/2"
- Pt #22"

CTH

Choose Your Hose Ends Pt

- 1" FNPT x 1" FNPTPt # F1
- 1 1/2" FNPT x 1 1/2" FNPTPt # F112
- 2" FNPT x 2" FNPTPt # F2

Length of Hose in Inches

Pt # _____

CTH –

 ID

BH →

*Custom length hoses are not returnable for either credit or refund.

CO2 ACCESSORIES Automatic Changeover Manifold Ball Valves

Utilizes Two Compensating Regulators

This Automatic Changeover Utilizes two compensating regulators to insure a seamless changeover from empty cylinder to full cylinder.

Features:

- For use with all inert gases
- Accurate and stable
- Changeover utilized two patented compensating regulators ensuring accuracy
- Smooth and silent changeover
- Quick and simple installation
- Durable and compact
- Ideal application for: Beverage Industry (fountain and keg service); Welding (uninterrupted shield gas flow for automated systems); Laboratory (ideal for application requiring a stable constant flow without interruption)

Specifications:

Max Inlet PSIG 3,000 PSIG
Size 5" W x 10" H x 2" D
Outlet Pressure 125 PSI - 170 PSI



Image shown does not contain pigtails
 Part # MAN-ACDR-NOPIGTAILS

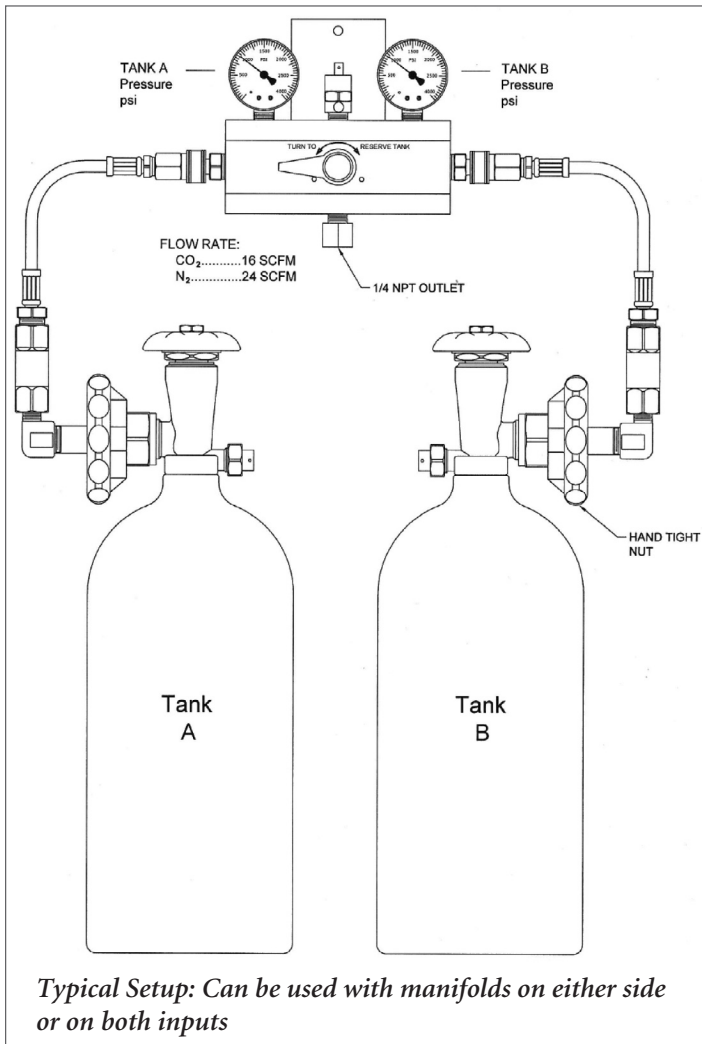

Typical Setup: Can be used with manifolds on either side or on both inputs

Part #	Description
MAN-ACDR	Automatic Changeover Manifold
MAN-ACDR-320-24	Automatic Changeover Manifold, with 24" Pigtails for Carbon Dioxide
MAN-ACDR-320-36	Automatic Changeover Manifold, with 36" Pigtails for Carbon Dioxide
MAN-ACDR-580-24	Automatic Changeover Manifold, with 24" Pigtails for Inert
MAN-ACDR-580-36	Automatic Changeover Manifold, with 36" Pigtails for Inert

WARNING: Products in this catalog can expose you to chemicals including Lead which is known to the State of California to cause cancer, birth defects or reproductive harm. For more information, go to <https://www.p65warnings.ca.gov>

Ball Valves, Carbon Steel with Vented Ball



Features:

- Forged Construction
- Raised Handle Stops
- Blowout proof stem design
- Adjustable packing gland
- Zinc phosphate corrosion protection
- Stainless Steel Ball and Stem
- Vented Ball
- 2,000 PSIG

Part #	Description
ABV-C14-SV-SSBS	1/4" F NPT
ABV-C38-SV-SSBS	3/8" F NPT
ABV-C12-SV-SSBS	1/2" F NPT
ABV-C34-SV-SSBS	3/4" F NPT
ABV-C1-SV-SSBS	1" F NPT

WARNING: Cancer and Reproductive Harm – www.P65Warnings.ca.gov
 For further information on Proposition 65, please go to www.oehha.ca.gov/proposition-65

Completely Automatic

This is a completely automatic gas cylinder changeover system that is non-electric, fool-proof and designed for easy installation and everlasting performance.

Installation Made Easy

- Simply fasten the Changeover to a wall with the outlet about 10" above the gas cylinders to be uses.
- Connect your regulator inlet to the outlet of the changeover.
- Connect the hoses to the cylinders being used.

After Installation, simply turn on the cylinders (or bank of cylinders) that will be used FIRST. This locks in this bank of cylinders.

Then turn on the other bank of cylinders which will be used SECOND. The automatic Changeover will automatically switch to this side when the pressure in the First bank drops to 185 psi (+/- 15 psi).

Materials of Construction

- Valve Body – 7075-T6 Aluminum
- Spool Valves – Brass, Nickel Plated
- O-Rings – EPDM

Weight & Dimensions

3"W x 5.5"H x 1.25"D – 5 lbs.

Inlet Pressure

3000 psig max

Changeover Pressure

185 psig +/- 15 psig

Flow Rates

- @ 2000 psig inlet: 2625 cfh
- @ 250 psig inlet: 525 cfh

CO2 Auto Changeovers*

Part #	Description
ACM-320-2	CGA 320 Auto Changeover, 2 Cylinders
ACM-320-4	CGA 320 Auto Changeover, 4 Cylinders
ACM-320-6	CGA 320 Auto Changeover, 6 Cylinders

Inert Auto Changeovers*

Part #	Description
ACM-580-2	CGA 580 Auto Changeover, 2 Cylinders
ACM-580-4	CGA 580 Auto Changeover, 4 Cylinders
ACM-580-6	CGA 580 Auto Changeover, 6 Cylinders



CO2 Auto Changeovers
Pigtail Length: 48 Inches
Part # ACM-320-2



Inert Auto Changeovers
Pigtail Length: 48 Inches
Part # ACM-580-4

REGULATOR OPTIONS

Part #	Description
BEV-RG320-160S	0-160 PSI CO2 Soda Regulator, Dual Gauge
BEV-RG320-60B	0-60 PSI CO2 Beer Regulator, Dual Gauge
BEV-RGS320-60B	0-60 PSI CO2 Beer Regulator, Single Gauge
BEV-RG580-160B	0-160 PSI Nitrogen Beer Regulator, Dual Gauge

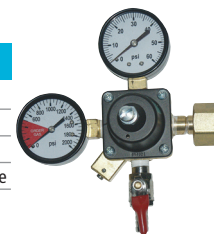

*** 20 year manufacturer warranty on these CO2 and Inert Automatic Changeovers**

⚠ WARNING: Products in this catalog can expose you to chemicals including lead which is known to the State of California to cause cancer, birth defects or reproductive harm. For more information, go to <https://www.p65warnings.ca.gov>

CO2 CYLINDER ACCESSORIES Semi-Automatic Switchover Manifold

Semi-Automatic Switchover Manifold

Prevents downtime by automatically switching gas supply from the primary cylinder bank to the reserve cylinder bank. The user resets the primary bank by turning the knob. Manual adjustment of the individual regulators is not required.

Features:

- Wall mounting Panel
- Maximum inlet pressure 3000 PSIG
- Delivery pressure 0 – 125 PSIG
- Inlet/Outlet 1/4 NPT
- Includes Post Sintered stainless steel braided pigtails.
- CGA Nut and Nipples with Check Valves

Optional Accessory

- High Pressure Alarm System, 3000 PSIG
Pt # MSO-SA-ALARMHP

Post sintered hoses are included as standard. Other hose options are available upon request.

reliably
RATERMANN

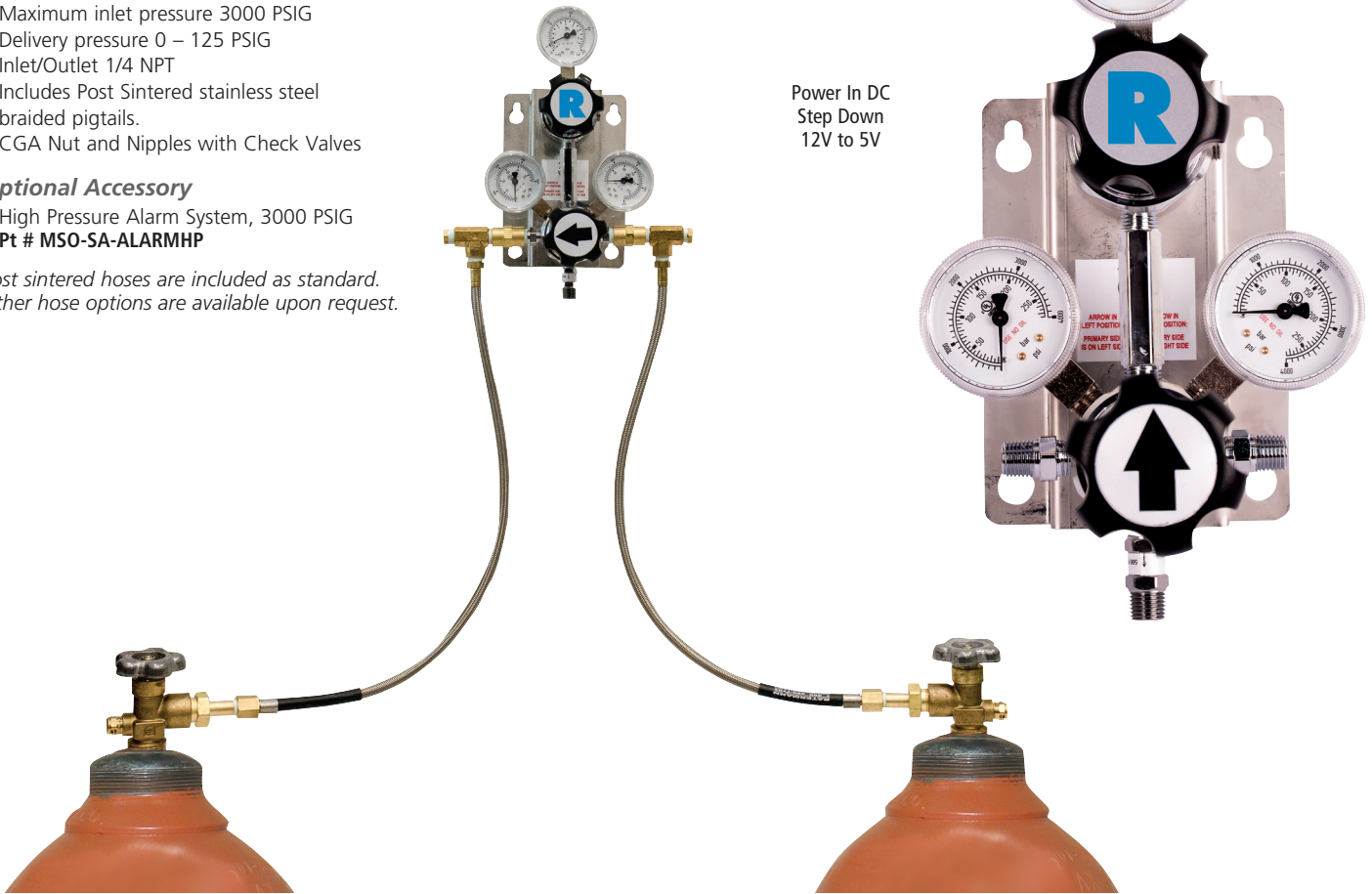

Ratermann Mfg. Semi-Automatic Switchover Manifolds



MSO-SA Model

Gas Service	CGA	PSI Range	2 Cylinder Manifold Part #	4 Cylinder Manifold Part #	6 Cylinder Manifold Part #
Carbon Dioxide	320	125 PSI	MSO-SA-320-2	MSO-SA-320-4	MSO-SA-320-6
Air-Breathing	346	125 PSI	MSO-SA-346-2	MSO-SA-346-4	MSO-SA-346-6
Hydrogen	350	125 PSI	MSO-SA-350-2	MSO-SA-350-4	MSO-SA-350-6
Medical Mixtures	500	125 PSI	MSO-SA-500-2	MSO-SA-500-4	MSO-SA-500-6
Oxygen	540	125 PSI	MSO-SA-540-2	MSO-SA-540-4	MSO-SA-540-6
Inert	580	125 PSI	MSO-SA-580-2	MSO-SA-580-4	MSO-SA-580-6
Air-Industrial	590	125 PSI	MSO-SA-590-2	MSO-SA-590-4	MSO-SA-590-6

WARNING: Products in this catalog can expose you to chemicals including lead which is known to the State of California to cause cancer, birth defects or reproductive harm. For more information, go to <https://www.p65warnings.ca.gov>

Transfill Pump with Scale



Cylinder Hanging Stand*
Part # TFPSA-CYLHKIT

Pt # TFPS-CO2

Features

- Liquefied Carbon Dioxide and Nitrous Oxide fill station
- Complete system, includes pump, scale and hose sets
- Excellent for on-demand filling of customers cylinders
- Patented double-ended pump with 9:1 ratio, fills at rate of 4 lbs. per minute
- Momentary fill button ensures operator attention
- "Economizer" fill valve bleeds pressure to cylinder while maintaining pressure in pump
- Lube free operation
- Powered by shop air or remaining pressure in spent cylinders

Specifications

Part Number: TFPS-CO2
 Drive Air Required: 90-140 psi
 Drive Ratio: 9:1
 Fill Rate: 4 lbs/min
 Pump: Liquid gases only
 Design: Aluminum Body – Heat Treated Stainless Steel Piston

Applications

- HVAC service cylinders
- Nitrous Oxide cylinders
- Paintball cylinders
- Class 2 fire extinguishers

Transfill Pump with Scale and Accessories

Part #	Description
TFPS-CO2	Transfill Pump with Scale
Part #	Accessory Descriptions
TFPSA-CYLHKIT	Cylinder Hanging Stand* for filling small cylinders (shown above)
TFPSA-PINACO2	Pin Valve Depressor
TFPSA-PO	Pump Only

⚠ WARNING: Products in this catalog can expose you to chemicals including Lead which is known to the State of California to cause cancer, birth defects or reproductive harm. For more information, go to <https://www.p65warnings.ca.gov>

DRY ICE
ON DEMAND, AS YOU NEED IT

Dry Ice Machine

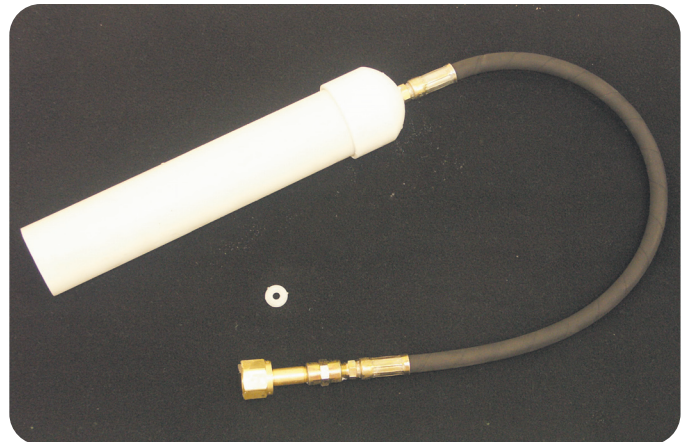

Pt # DIM-DW1

for Cryogenic Liquid Cylinders

You will need a Liquid Cylinder (350psi Cryotank) of Liquid CO2.

Attach to the Liquid outlet of your Bulk CO2 tank using an Adjustable wrench. Open the cylinder valve and direct the nozzle into a container.

One way to pack dry ice is by packing it into a small cardboard box. Pack it down with a 2x4, and tape it shut. Put the cardboard box into your cooler or insulated container.

Makes Dry Ice snow at the rate of 1 + lbs. every two minutes.

for High Pressure Tanks

CO2 tank needs to be a liquid withdrawal tank that has a dip tube inside the tank so liquid comes out to produce dry ice.

Attach to the 0 to 70 lb (high pressure) Dip Tube/Siphon CO2 Cylinder using an Adjustable wrench. Open the cylinder valve and direct the nozzle into a container.

Another way to use your dry ice, is to spread a couple layers of newspaper on a hard surface. Dump the Dry Ice from the bag or container onto the newspaper. Wrap your dry ice like a burrito in the newspaper and tape it shut. Place in cooler.

Makes Dry Ice snow at the rate of 1 lb. every two minutes.

⚠ WARNING: Products in this catalog can expose you to chemicals including Lead which is known to the State of California to cause cancer, birth defects or reproductive harm. For more information, go to <https://www.p65warnings.ca.gov>

Manual CO2 Cylinder Changeovers

AN AFFORDABLE ALTERNATIVE TO AUTOMATIC CHANGEOVERS

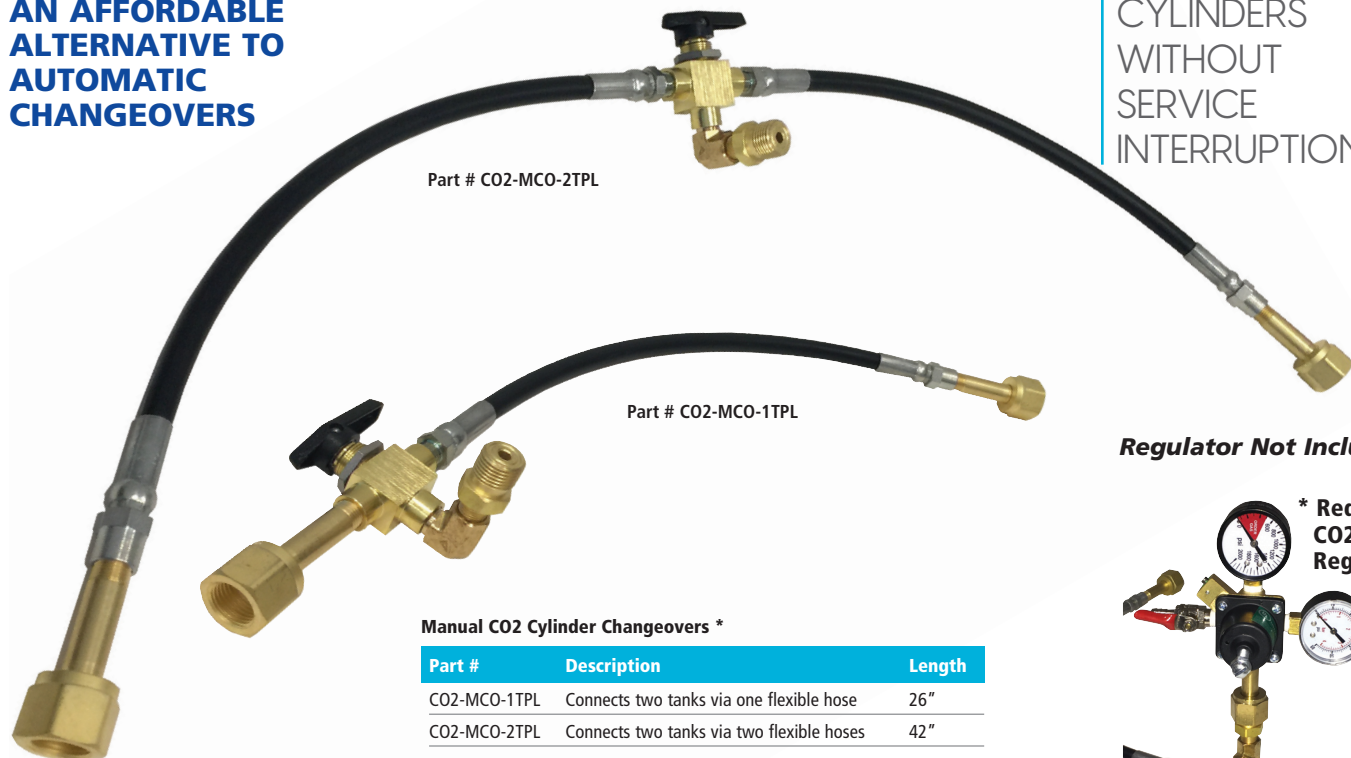

SWITCH CYLINDERS WITHOUT SERVICE INTERRUPTION

Regulator Not Included



Manual CO2 Cylinder Changeovers *

Part #	Description	Length
CO2-MCO-1TPL	Connects two tanks via one flexible hose	26"
CO2-MCO-2TPL	Connects two tanks via two flexible hoses	42"

Low Pressure Changeover Valve

SWITCH CYLINDERS WITHOUT SERVICE INTERRUPTION

LOW COST ALTERNATIVE TO HIGH PRESSURE AND AUTO CHANGEOVERS

Connect valve to the low pressure outlets of two regulators via beverage tubing and 1/4" MFL fittings.

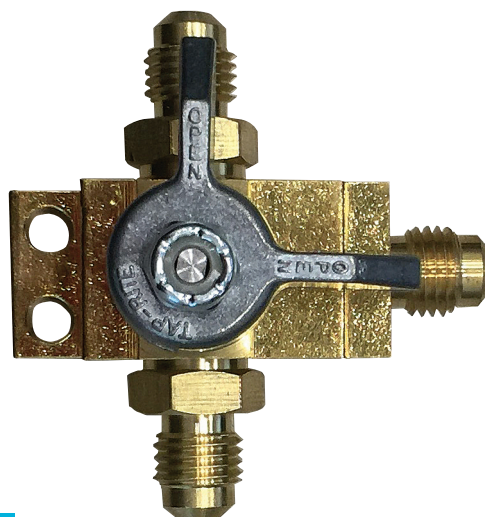

Economy
Part # CO2-CV-E

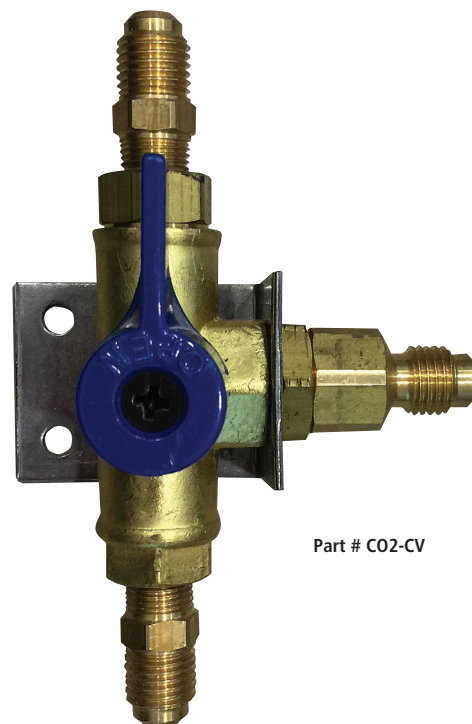

Part # CO2-CV

Low Pressure Changeover Valve

Part #	Description
CO2-CV	Low Pressure Changeover Valve
CO2-CV-E	Economy Low Pressure Changeover Valve

WARNING: Products in this catalog can expose you to chemicals including lead which is known to the State of California to cause cancer, birth defects or reproductive harm. For more information, go to <https://www.p65warnings.ca.gov>

Nitrogen Beer & Beer Regulators Soda Regulators

Nitrogen Beer Regulators

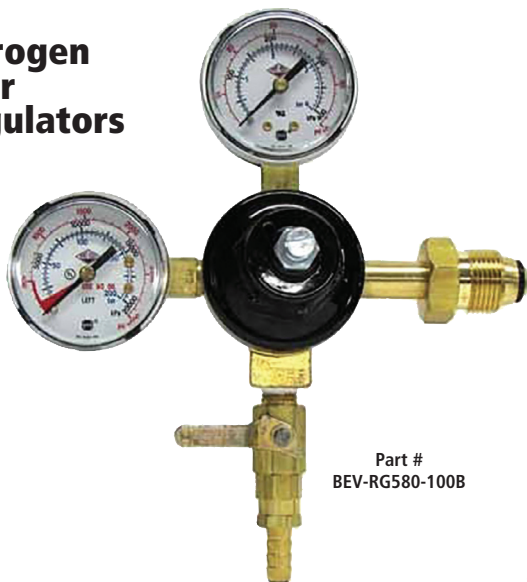

Part #
BEV-RG580-100B



Nitrogen Beer Regulator 0-100 PSI

Part #	Description
BEV-RG580-100B	Nitrogen Beer Regulator 0-100 PSI

Nitrogen Beer Regulator 0-60 PSI

Part #	Description
BEV-RG580-60B	Nitrogen Beer Regulator 0-60 PSI

Nitrogen Beer Regulator 0-160 PSI

Part #	Description
BEV-RG580-160B	Nitrogen Beer Regulator 0-160 PSI



Part #
BEV-RG580-160B

Beer Regulator

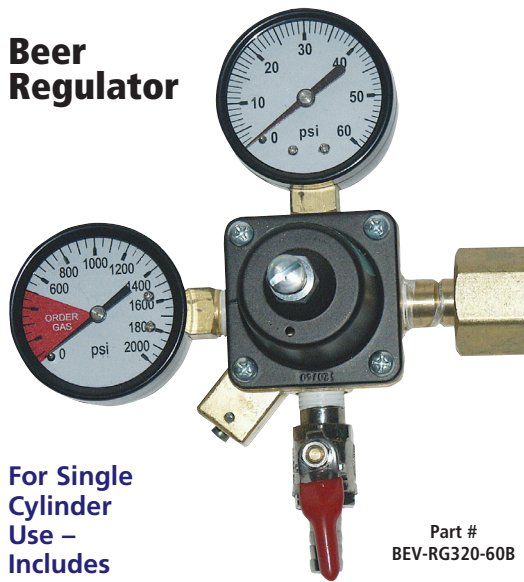

Part #
BEV-RG320-60B

For Single Cylinder Use – Includes Shutoff Valve

0-60 P.S.I.

Beer Regulator

Part #	Description
BEV-RG320-60B	Beer Regulator



Soda Regulator

For Single Cylinder Use – No Shutoff Valve

0-160 P.S.I.

Soda Regulator

Part #	Description
BEV-RG320-160S	Soda Regulator

Replacement Gauge for CO2 Regulator

Part #	Description
BEV-PG2LH14-2000	2" Dial, 0-2000 PSI 1/4" LH (left hand)

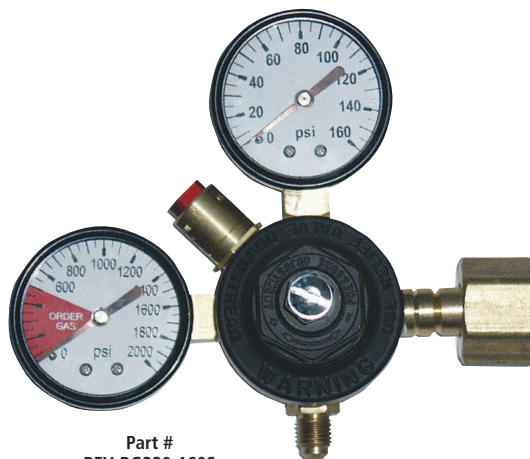

Part #
BEV-RG320-160S



WARNING: Products in this catalog can expose you to chemicals including lead which is known to the State of California to cause cancer, birth defects or reproductive harm. For more information, go to <https://www.p65warnings.ca.gov>

Secondary Regulators Cylinder Valve Sizing Chart for Steel & Aluminum

Secondary Regulators

Secondary Regulator

Part #	Description
BEV-RGS-100FL14	Secondary Regulator 0-100
BEV-RGS-160FL14	Secondary Regulator 0-160
BEV-RGS-60FL14	Secondary Regulator 0-60

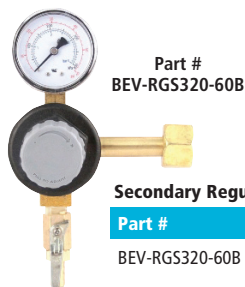

Secondary Regulator – Single Gauge

Part #	Description
BEV-RGS320-60B	Secondary Regulator 0-60 PSI Single Gauge CO2

Part #
BEV-RGS-100FL14

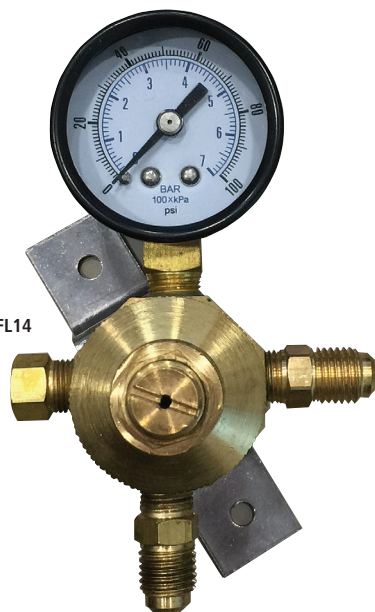

Economy Replacement Gauges

For more Gauges see page BEV-35



Low Mount Economy Gauges

Part #	Description
PG-ELM-30	Low Mount Economy Gauge 0-30 PSI
PG-ELM-60	Low Mount Economy Gauge 0-60 PSI
PG-ELM-100	Low Mount Economy Gauge 0-100 PSI
PG-ELM-160	Low Mount Economy Gauge 0-160 PSI
PG-ELM-300	Low Mount Economy Gauge 0-300 PSI

WARNING: Products in this catalog can expose you to chemicals including lead which is known to the State of California to cause cancer, birth defects or reproductive harm. For more information, go to <https://www.p65warnings.ca.gov>

PTFE Paste & Tape Oxygen Safe, Chemically Inert & Odor Free

FORMULA-8 is used by thousands of welding and general supply companies and equipment manufacturers worldwide.

Part #	Description
TAPE-1	1/4" PTFE Tape
TAPE-2	1/2" PTFE Tape
TAPE-34	3/4" PTFE Tape
TAPE-3	1" PTFE Tape
TAPE-2-GREEN	1/2" x 520" Green PTFE Tape
TAPE-34-GREEN	3/4" x 520" Green PTFE Tape
OXY-PTFE-8	PTFE Paste



Gauge Protector Boot



Gauge Protector Boot

Part #	Description
GP-BT	Gauge Protector Boot

VALVE SIZING CHART

Place Valve Thread End of Valve to Match Up to Diameter on the Chart

STEEL CYLINDER GUIDE

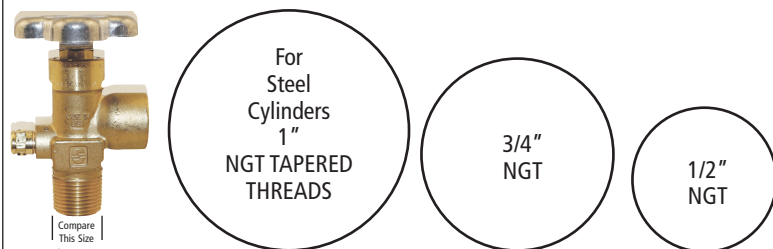

Typical Steel Cylinder Sizes

D & E Steel Medical Tank, CO ² 2-1/2#, 5#, 10#	1/2"
80 cu. ft. - 330, CO ² 20#, 30#, 40 cu. ft., 50 lb. CO ² Most other Cap Style Tank	3/4"
	1"

Thread Size

This guide is for a typical valve.

All Rights Reserved 2013

Not all valve and thread sizes are included. Please use this as a general guide.

ALUMINUM CYLINDER GUIDE



Typical Valve Aluminum Cylinder

Medical Aluminum Cylinder Mw-M4, M6, M7, M9, D, E - 2-1/2# CO ²	.750"
CO ² 50 lb. thru 5 lb.	1.125"

Thread Size

This guide is for a typical valve.

All Rights Reserved 2015

Not all valve and thread sizes are included. Please use this as a general guide.

GSV SERIES VALVES ARE MANUFACTURED WITH A DURABLE FORGED BRASS BODY AND PRECISELY MACHINED INTERNAL COMPONENTS TO PROVIDE YEARS OF TROUBLE FREE SERVICE

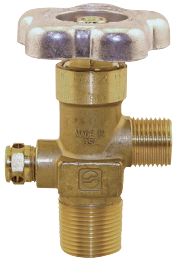

3/4" NGT Tapered Thread, Brass

New Part #	Old Part #	Safety
SHW-GSV32060	SHW-GV32060	NO SAFETY
SHW-GSV32061-28	SHW-GV32061-28	3000 PSI
SHW-GSV32061-32	SHW-GV32061-32	3360 PSI
SHW-GSV32061-35	SHW-GV32061-35	3775 PSI
SHW-GSV32061-38	SHW-GV32061-38	4000 PSI

New # SHW-GSV32061-32
Old Pt # SHW-GV32061-32

3/4" NGT Tapered Thread, Chrome

New Part #	Old Part #	Safety
SHW-GSVA32061-28	SHW-GVA32061-28	3000 PSI
SHW-GSVA32061-32	SHW-GVA32061-32	3360 PSI
SHW-GSVA32061-35	SHW-GVA32061-35	3775 PSI
SHW-GSVA32061-38	SHW-GVA32061-38	4000 PSI

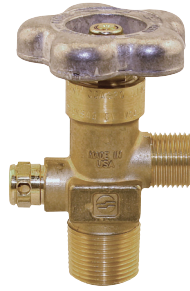

3/4" NGT +4 Over Size Tapered Thread, Brass

New Part #	Old Part #	Safety
SHW-GSV32061-28-4	SHW-GV32061-28-4	3000 PSI
SHW-GSV32061-32-4	SHW-GV32061-32-4	3360 PSI
SHW-GSV32061-35-4	SHW-GV32061-35-4	3775 PSI
SHW-GSV32061-38-4	SHW-GV32061-38-4	4000 PSI

New # SHW-GSV32061-32-7
Old Pt # SHW-GV32061-32-7

3/4" NGT +7 Over Size Tapered Thread, Brass

New Part #	Old Part #	Safety
SHW-GSV32061-28-7	SHW-GV32061-28-7	3000 PSI
SHW-GSV32061-32-7	SHW-GV32061-32-7	3360 PSI
SHW-GSV32061-35-7	SHW-GV32061-35-7	3775 PSI
SHW-GSV32061-38-7	SHW-GV32061-38-7	4000 PSI



1/2" NGT Tapered Thread, Brass

New Part #	Old Part #	Safety
SHW-GSV32040	SHW-GV32040	NO SAFETY
SHW-GSV32041-28	SHW-GV32041-28	3000 PSI
SHW-GSV32041-32	SHW-GV32041-32	3360 PSI
SHW-GSV32041-35	SHW-GV32041-35	3775 PSI
SHW-GSV32041-38	SHW-GV32041-38	4000 PSI

New # SHW-GSV32041-28
Old Pt # SHW-GV32041-28



1" NGT Tapered Thread, Brass

New Part #	Old Part #	Safety
SHW-GSV32081-28	SHW-GV32081-28	3000 PSI
SHW-GSV32081-32	SHW-GV32081-32	3360 PSI
SHW-GSV32081-35	SHW-GV32081-35	3775 PSI
SHW-GSV32081-38	SHW-GV32081-38	4000 PSI

New # SHW-GSV32081-28
Old Pt # SHW-GV32081-28

3/4" NGT +7 Over Size Tapered Thread, Chrome

New Part #	Old Part #	Safety
SHW-GSVA32061-32-7	SHW-GVA32061-32-7	3360 PSI
SHW-GSVA32061-35-7	SHW-GVA32061-35-7	3775 PSI
SHW-GSVA32061-38-7	SHW-GVA32061-38-7	4000 PSI

1" NGT Tapered Thread, Chrome

New Part #	Old Part #	Safety
SHW-GSVA32081-28	SHW-GVA32081-28	3000 PSI
SHW-GSVA32081-32	SHW-GVA32081-32	3360 PSI
SHW-GSVA32081-35	SHW-GVA32081-35	3775 PSI
SHW-GSVA32081-38	SHW-GVA32081-38	4000 PSI



1-1/8" UNF Straight Thread, Brass with Lexan Handwheels

New Part #	Old Part #	Safety
SHW-GSV32051-28LX	SHW-GV32051-28LX	3000 PSI
SHW-GSV32051-32LX	SHW-GV32051-32LX	3360 PSI
SHW-GSV32051-38LX	SHW-GV32051-38LX	4000 PSI

New # SHW-GSV32051-28LX
Old Pt # SHW-GV32051-28LX

3/4" UNF Straight Thread, Brass with Lexan Handwheels

New Part #	Old Part #	Safety
SHW-GSV32051-28LX-75	SHW-GV32051-28LX-75	3000 PSI
SHW-GSV32051-32LX-75	SHW-GV32051-32LX-7	3360 PSI
SHW-GSV32051-35LX-75	SHW-GV32051-35LX-75	3775 PSI
SHW-GSV32051-38LX-75	SHW-GV32051-38LX-75	4000 PSI

5/8" UNF Straight Thread, Brass with Lexan Handwheels

New Part #	Old Part #	Safety
SHW-GSV32051-28LX-62	SHW-GV32051-28LX-62	3000 PSI
SHW-GSV32051-32LX-62	SHW-GV32051-32LX-62	3360 PSI
SHW-GSV32051-35LX-62	SHW-GV32051-35LX-62	3775 PSI
SHW-GSV32051-38LX-62	SHW-GV32051-38LX-62	4000 PSI

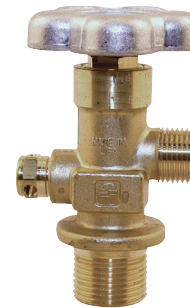

New # SHW-GSV32051-28
Old Pt # SHW-GV32051-28

1-1/8" UNF Straight Thread, Brass

New Part #	Old Part #	Safety
SHW-GSV32051-28	SHW-GV32051-28	3000 PSI
SHW-GSV32051-32	SHW-GV32051-32	3360 PSI
SHW-GSV32051-35	SHW-GV32051-35	3775 PSI
SHW-GSV32051-38	SHW-GV32051-38	4000 PSI

3/4" UNF Straight Thread, Brass

New Part #	Old Part #	Safety
SHW-GSV32051-28-75	SHW-GV32051-28-75	3000 PSI
SHW-GSV32051-32-75	SHW-GV32051-32-75	3360 PSI
SHW-GSV32051-35-75	SHW-GV32051-35-75	3775 PSI
SHW-GSV32051-38-75	SHW-GV32051-38-75	4000 PSI

Gas Tight Brass Plug & Chain Assemblies for CGA 320

- Gas tight one piece plug and chain assembly



Part No.	CGA No.	Description	Gas Tight Seal
FIT-OPC-320	320	Carbon Dioxide-RH-Internal	3000 P.S.I.G.

WARNING: Cancer and Reproductive Harm – www.P65Warnings.ca.gov

WARNING: Cancer and Reproductive Harm – www.P65Warnings.ca.gov

Replacement Safety Reliefs



Part Number	Description
SHW-P625-19N9-28	Sherwood GV Series Plug Style Safety 3000 PSI
SHW-P625-19N9-32	Sherwood GV Series Plug Style Safety 3360 PSI
SHW-P625-19N9-35	Sherwood GV Series Plug Style Safety 3775 PSI
SHW-P625-19N9-38	Sherwood GV Series Plug Style Safety 4000 PSI

Replacement fusible plugs also available. Old cap style available upon request. Call Customer Service for details.

Cylinder Siphon Tubes

Siphon tubes are constructed from 3/8" type "K" copper tube. Each tube is fitted with a 1/4" male NPT brass fitting for easy attachment to most brass valves on the market today. Standard length is 53" OAL to fit most 250-300 cu. ft. cylinders. All ends are cut at 45° angle to allow for unrestricted flow.

Stainless Steel siphon tubes are available for higher purity gases. Custom sizes are available upon request. Call Customer Service for details.

WARNING: Cancer and Reproductive Harm – www.P65Warnings.ca.gov



Part # CST-C

Cylinder Siphon Tubes

Part #	Description
CST-S	Standard Siphon Tube, 53" OAL
CST-C	Standard Siphon Tube, 48" OAL
CST-C26	Standard Siphon Tube, 26" OAL

CO2 PRODUCTS Carbon Dioxide and Gas Purification

Improve Carbonation

Advanced technology now provides a filter for both solid particulate and oil mist reduction. The excellent specifications for solid particulate reduction, oil aerosols and vapor reduction translate into increased carbonation and efficiency. Provides 40 times more solid particulate holding capacity than conventional filters.

Applications include beverage carbonation and brewing operations, gas packaging, injection molding, processing, medical uses, refrigeration / chilling systems and a host of others to meet your needs.

Our modular filter design means less than half of the installation time of conventional systems plus reduced maintenance over years of use. This unique system utilizes nylon construction and will withstand high pressure – yet maintain a low pressure drop. And you'll appreciate our filter performance guarantee to enhance many years of dependable use under the most rigorous conditions.

Materials of Construction:

Filter Media	Hollow Carbon
Housing	Polypropylene
Head	Proprietary reinforced nylon

Cartridge Specifications and Performance Data

Maximum Dimensions	14" x 9" x 23"
Micron Rating	0.5
Initial ΔP (psi) at Flow Rate (gpm)	8 psi @ 150 scfm
Temperature Rating	40° to 100° F

Applications:

- CO2 & GAS PURIFICATION
- Beer & Beverage Carbonation
- Bottling and brewing
- Gas Packaging
- Chilling, Quick Freezing & Refrigeration
- Fire Extinguishers
- Medical & Surgical Uses
- Critical Instrumentation
- Industrial CO2 Laser Cutting & Welding
- Blending, Foaming & Injection Molding
- Micro-Elements
- Ceramics Processing
- Holography

Benefits:

- One Filter does it all
- No pre filter required
- Low pressure drop
- Increase Carbonation

Features:

- Ultra High Porosity Carbon with Micro-Structure
- Nylon construction withstands high pressure
- Modular filter design for up to 80% less installation time!
- 40 times more solid particulate holding capacity than conventional filters!

Specified to:

- Provide 100% 0.5-1 Micron Solid Particulate Reduction
- Provide 100% Oil Aerosols and Vapor Reduction at 61 mg/m³
- Increase Carbonation

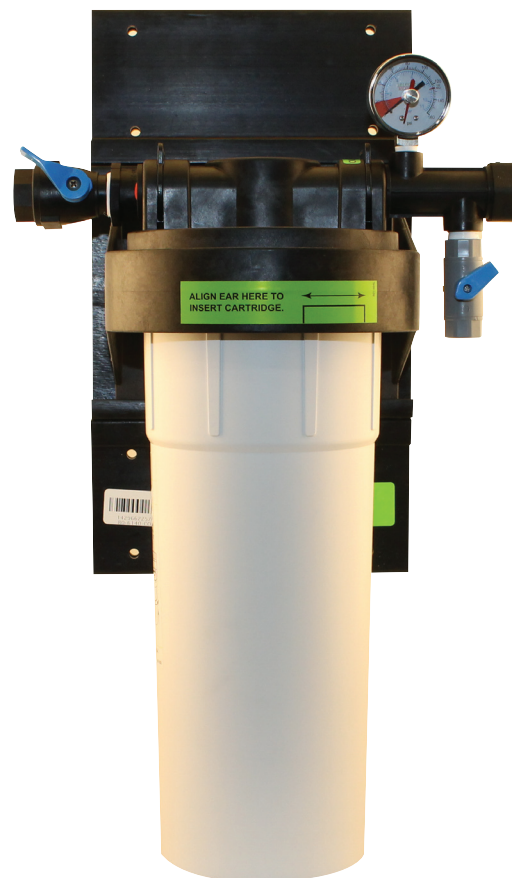

Part #	Description
PFS-CO2	Purification System
PFS-CO2-RC	Replacement Cartridge

COMPLETE LINE
OF CARBON DIOXIDE
DELIVERY HOSES...

**Call Customer Service
at 1-800-264-7793 to
Fill Your Hose Needs
for Your Application.**

⚠ WARNING: Products in this catalog can expose you to chemicals including lead which is known to the State of California to cause cancer, birth defects or reproductive harm. For more information, go to <https://www.p65warnings.ca.gov>

SEAL
FOR FILLING
CO2 TANKS



O-Ring for CC1-STEM
Part # CC1-STEM-OR



Seals – Permanent
ABC Units
Part # CC-1



Economy
Seal
Part # CC-P1



Stems – 103 SF
2 1/2" - 1/4" pipe
Part # CC1-STEM



Grip-Nut 103N
Part # CC1-NUT

**Easy Connecting
and Disconnecting
from Cylinder**

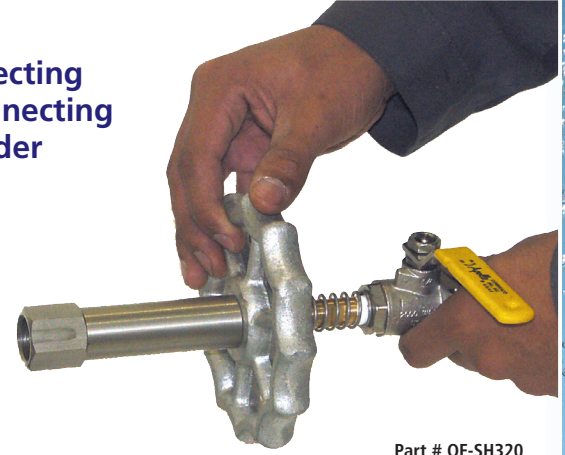

Part # QF-SH320

Quick Fill Connector for Carbon Dioxide

Part #	Description
QF-SH320	Carbon Dioxide – Hand Spin On

Replacement Parts for Pt # QF-SH320



EASY
TO REPLACE SEAL FOR
FILLING CO2 TANKS

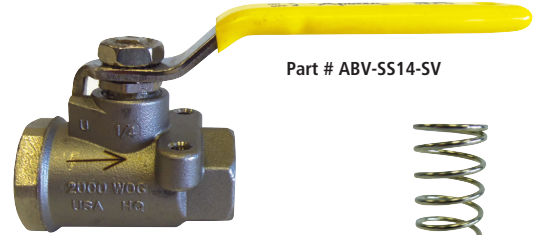

Part # ABV-SS14-SV



Part #
QF-SH320-SPRING



Part # QF-SH320-KEY



Part #
QF-SH320-SETSCW8-32-14



Part # QF-SH320-RHM



Part # QF-SH320-HT



Part # QF-SH320-BIR

WARNING: Products in this catalog can expose you to chemicals including lead which is known to the State of California to cause cancer, birth defects or reproductive harm. For more information, go to <https://www.p65warnings.ca.gov>

Carbon Dioxide Cylinder Shoulder Labels

All Labels are GHS Compliant

For Custom Imprint Labels... to Promote Your Brand

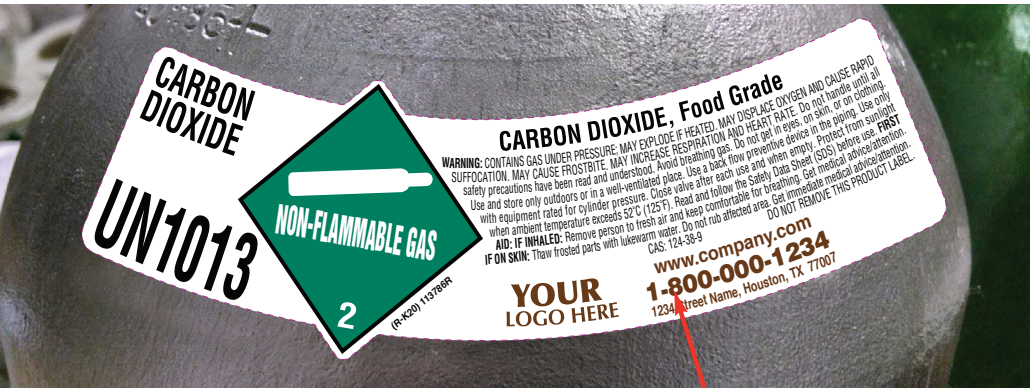

Add your Custom Imprint information here.

Cylinder Shoulder Labels (CO2 & Blended Gas)

Part #	Description	On Roll	Gas Type	UN #
GCS-CD-XXX-PK500	Shoulder Label	500	Carbon Dioxide	UN1013
GCS-CG75AR25CO2-XXX-PK500	Shoulder Label	500	Compressed Gases NOS (75% Argon, 25% CO2)	UN1956
GCS-CD-BEV-XXX-PK500	Custom Shld Label	500	Carbon Dioxide Beverage Grade	UN1013
GCS-CD-FG-XXX-PK500	Shoulder Label	500	Carbon Dioxide (Food Grade)	UN1013
GCS-CD-FGBEV-XXX-PK500	Custom Shld Label	500	CO2, Food Grade & Beverage Grade	UN1013
GCS-CG-BG60CD40NI-XXX-PK500	Shoulder Label	500	Beer Gas Com Gases NOS (60% CO2, 40% Nitrogen)	UN1956
GCS-CG-BG75NI25CD-XXX-PK500	Custom Shld Label	500	Beer Gas Com Gas NOS (75% Nitrogen, 25% CO2)	UN1956
GCS-CG-BGFG60CD40NI-XXX-PK500	Custom Shld Label	500	Beer Gas Food Grade (60% CO2, 40% Nitrogen)	UN1956

Carbon Dioxide Cylinder Status Tags

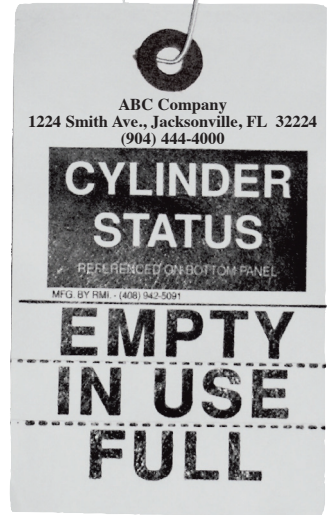

Sample of Company Information Imprint

Pt # CB-C2PEFT1

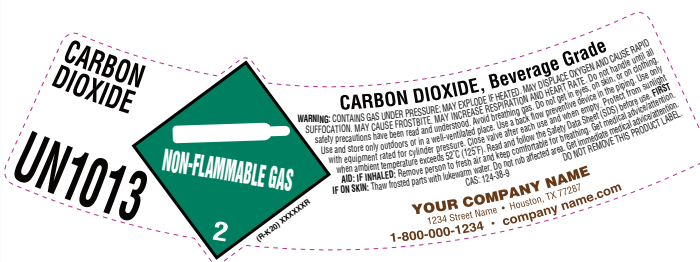

Carbon Dioxide, Beverage Grade
Pt # GCS-CD-BEV-XXX-PK500



Beer Gas, Compressed Gases NOS (60% CO2, 40% Nitrogen)
Pt # GCS-CG-BG60CD40NI-XXX-PK500

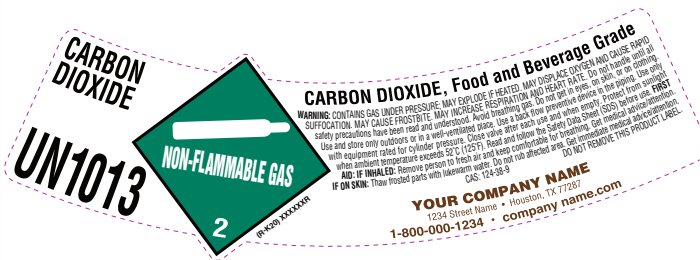

Carbon Dioxide, Food Grade & Beverage Grade
Pt # GCS-CD-FGBEV-XXX-PK500

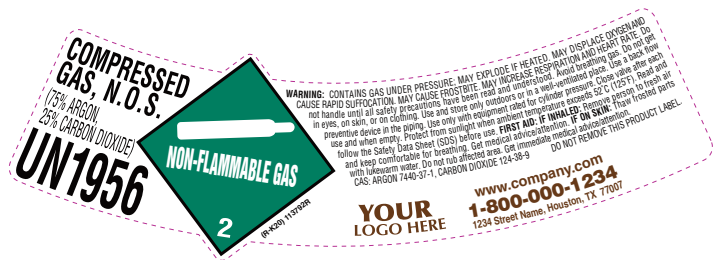

Compressed Gases NOS (75% Argon, 25% CO2)
Pt # GCS-CG75AR25CO2-XXX-PK500

USE CGA DUST COVERS AND THREAD PROTECTORS

Use CGA Dust Cover and Thread Protectors in your procedures – to keep dust and dirt out of the valves along with using valve shrink wrap for a package delivered that customer knows the product has not been used or tampered with.

Flexible Thread Protector for CO2

- Male Thread Valves



CGA 320
Dust Cap – Red
Pt # PM-2PK1000
Pt # PM-2PK100



Dust Cap with Strap

Fits all CO2 tank valves. Eliminates cap and chain. Protects threads and holds washer.

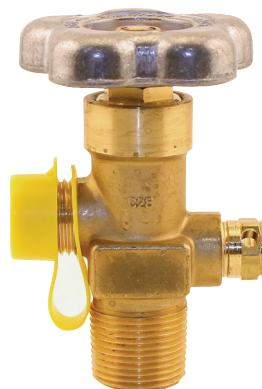

CGA 320
Dust Cap – Yellow
Pt # PM-C12-YPK1000
Pt # PM-C12-YPK100

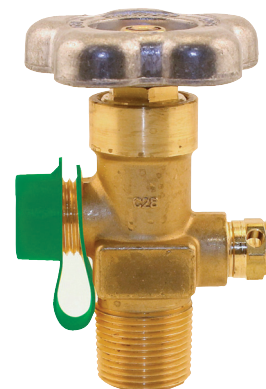

CGA 320
Dust Cap – Green
Pt # PM-C12-GRP1000
Pt # PM-C12-GRP100

Ridgid Plastic with Pull Tab for CO2

- Provides thread protection



CGA 320
Male Cover – Blue
Pt # PF-HB1PK1000
Pt # PF-HB1PK100

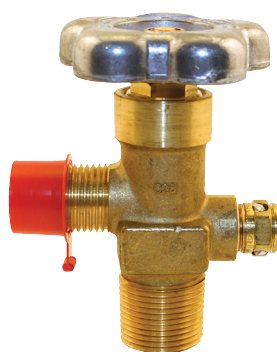

CGA 320
Male Cover – Red
Pt # PF-H1PK1000
Pt # PF-H1PK100

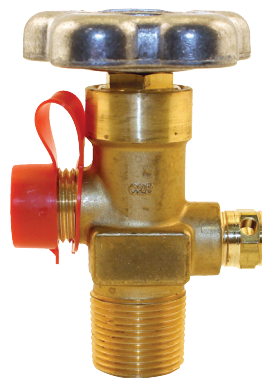

CGA 320
Dust Cap – Red
Pt # PM-C12-RPK1000
Pt # PM-C12-RPK100



CGA 320
Dust Cap – Blue
Pt # PM-C12-BPK1000
Pt # PM-C12-BPK100

CGA Plugs are available in Packs of 1,000 (PK1000) and Packs of 100 (PK100)

Note: All colors shown are printed representations. Actual colors may vary.

CO2 CYLINDER ACCESSORIES Carry Handles for Aluminum Cylinders

PROTECTS THE VALVE AND AIDS IN THE TRANSPORTATION OF THE CYLINDER

- KIDDE NECK = 2-3/16" diameter
- LUXFER NECK = 2-3/8" diameter
- CATALINA NECK = 2-5/8" diameter



Catalina® Style Pt # CCH-AC-BK
AC Style: OD = 3-7/8", ID = 2-3/4"

Luxfer® Style Pt # CCH-AL-BK
AL Style: OD = 3-7/8", ID = 2-1/2"

Black (BK)

Blue (B)

Red (RR)

Yellow (Y)

Green (GR)

Orange (O)

Note: All colors shown are printed representations. Actual colors may vary.

Aluminum Cylinder Carry Handles

Plastic Valve Protection Carry Handles are available to fit Catalina® and Luxfer® brand aluminum cylinders. We stock carry handles and retaining rings for both manufacturers cylinders. For 15 and 20 lb. Aluminum cylinders. Can be installed without removing valve.

For 15 & 20 lb. Aluminum Cylinders

Part #	Description
CCH-AC-xx	Catalina® Style Carry Handle
CCH-AC-R	Retaining Ring for Catalina® Style Carry Handles
CCH-AL-xx	Luxfer® Style Carry Handle
CCH-AL-R	Retaining Ring for Luxfer® Style Carry Handles
CCH-AS-xx	Thread On Style Carry Handle

Ordering Information:

Replace xx in the part number with the color codes below
Black – BK, Blue – B, Red – RR, Yellow – Y, Green – GR, Orange – O

Kidde Style Aluminum Cylinder Carry Handles



Pt # CCH-AK-BK

Pt # CCH-AK-BL

Pt # CCH-AK-RED

Kidde Style Aluminum Cylinder Carry Handles

Part #	Description
CCH-AK-BK	Kidde Style Cylinder Carry Handle and Retaining Ring, Black
CCH-AK-BL	Kidde Style Cylinder Carry Handle and Retaining Ring, Blue
CCH-AK-RED	Kidde Style Cylinder Carry Handle and Retaining Ring, Red

Installing Carry Handles for Aluminum Cylinder



1



2



3

Premium Carry Handles



Pt #
CHP-AC-BK

Pt # CHP-AL-BK

AC Style: OD = 3-7/8", ID = 2-3/4"
AL Style: OD = 3-7/8", ID = 2-1/2"

Premium Carry Handles

Part #	Description
CHP-AC-BK	Catalina Style Cylinder Premium Carry Handle and Retaining Ring, Black
CHP-AL-BK	Luxfer Style Cylinder Premium Carry Handle and Retaining Ring, Black

Premium Carry Handles that Pass DOT Drop Test



Pt # CHPDT-AC-BK

AC Style: OD = 3-7/8", ID = 2-3/4"

Premium Carry Handles that Pass DOT Drop Test

Part #	Description
CHPDT-AC-BK	Catalina style Cylinder Premium Carry Handle Passes DOT Drop Test and Retaining Ring, Black

CO2 CYLINDER ACCESSORIES Steel Cylinder Accessories

Cylinder Safety Conversion Kit

Handle & snap ring with steel cylinder adapter. Allows addition of plastic carrying handle to steel cylinders.

(Adapter comes with set screws.)



Valve must be removed to install handle.

Part #	Description
CCH-118	Conversion Kit 1.9"

CO2 Wrenches

Offered in two different styles

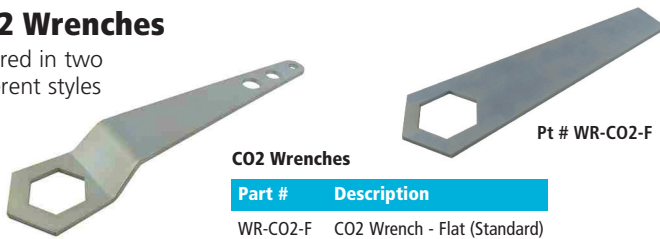

Pt # WR-CO2-O

Pt # WR-CO2-F

CO2 Wrenches

Part #	Description
WR-CO2-F	CO2 Wrench - Flat (Standard)
WR-CO2-O	CO2 Wrench - Offset

Small Cylinder Status Tags

Economy Paper Tags

MOST COMMON

MOST PREFERRED BY CUSTOMERS

Elastic Tie
Pt # CB-1EPTI



String Tie
Pt # CB-EPT

The String Tie does not stretch or loop around the cylinder.

Small Economy Paper Tags

Part # for Pkg. of 1000	Description	Part # for Pkg. of 100
CB-EPTPK1000	String Tie	(Pt # CB-EPTPK100)
CB-1EPTIPK1000	Elastic Tie	(Pt # CB-1EPTIPK100)

Cylinder Retaining Rings for Carry Handles



Catalina® Style
Pt # CCH-AC-R



Luxfer® Style
Pt # CCH-AL-R

Cylinder Retaining Rings

Part #	Description
CCH-AC-R	Retaining ring for Catalina®
CCH-AL-R	Retaining ring for Luxfer®



Installing carry handle valve protector

Retaining Ring Plier

For all cylinder handle retaining rings.

Part #	Description
CCH-P1	Retaining Ring Plier

PTFE Seals for CO2

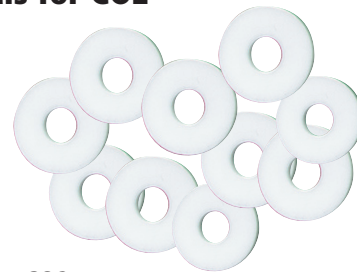

PTFE Seals for CO2

Description	Part # for Pack of 100	Part # Pack of 10
PTFE Seals for CO2	CO2-TWSEALPK100	CO2-TWSEALPK10
FIBRE, 320/330	PH-320WFPK100	PH-320WFPK10

Cylinder Boots

The Cylinder Boot is made out of black molded plastic. Slip onto round bottom CO2 tanks to convert to upright standing cylinders.



Allows most older, round bottom cylinders to free stand

Molded Plastic Cylinder Boot, 8" Diameter
Part # CO2-C8



Octagonal Steel Cylinders with round bottom
Part # CO2-CDB-S07



Round Rim Aluminum Cylinders with flat bottom
Part # CO2-CDB-AR7

Part Number	Diameter	Rim	Cylinder Type
CO2-CDB-A07	7.25" Dia	Octagonal	Aluminum Cylinders (flat bottom)
CO2-CDB-AR7	7.25" Dia	Round Rim	Aluminum Cylinders (flat bottom)
CO2-CDB-S07	7.25" Dia	Octagonal	Steel Cylinders (round bottom)
CO2-CDB-SR7	7.25" Dia	Round Rim	Steel Cylinders (round bottom)
CO2-CDB-A08	8" Dia	Octagonal	Aluminum Cylinders (flat bottom)
CO2-CDB-SR8	8" Dia	Round Rim	Steel Cylinders (round bottom)
CO2-CB	8" Dia	Round Rim	Older, Round bottoms to free stand

High Pressure Cylinder Caps



Caps Painted Black
6 1/2" – 3 1/8-11



Caps Unpainted
6 1/2" – 3 1/8-11

INSIDE CAP CYLINDER THREADS

Fine Thread:
11 threads to an inch

Coarse Thread:
7 threads to an inch.
Cap I.D. is 3 1/4

► **MOST COMMON Fine Thread**

Unpainted High Pressure Cylinder Caps

Part #	Description
8FRNP	Fine Thread
8CRNP	Coarse Thread

Painted – Fine Thread

Part #	Color
► 8FRNP-08	White
► 8FRNP-02	Black
► 8FRNP-06	Gray
► 8FRNP-MGR	Green Medical

Painted – Coarse Thread

Part #	Color
8CRNP-08	White
8CRNP-02	Black
8CRNP-06	Gray

⚠ WARNING: Products in this catalog can expose you to chemicals including lead which is known to the State of California to cause cancer, birth defects or reproductive harm. For more information, go to <https://www.p65warnings.ca.gov>

Cap Wrench for Removing those "hard-to-open" caps



Cap Wrench
Pt # CW-CAP

Cylinder Cap and Regulator Inlet Nut Wrench



Pt # ATW-1027

Dewar Rear Mount Pressure Gauges

Gauges are bagged and tagged for oxygen service and comply with the requirements of ASME B40.1 Level 1V clean lines.



Part # PG-400



Packaged Gauge

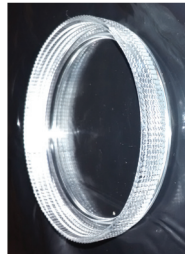

Part # RL2.0-TWIST

1/4" NPT Rear Mount Pressure Gauges

Part #	PSI	Description
PG-60	0-60 PSI	2" Dial, 1/4" NPT Rear Mount Pressure Gauges
PG-100	0-100 PSI	2" Dial, 1/4" NPT Rear Mount Pressure Gauges
PG-400	0-400 PSI	2" Dial, 1/4" NPT Rear Mount Pressure Gauges
PG-600	0-600 PSI	2" Dial, 1/4" NPT Rear Mount Pressure Gauges
RL2.0-TWIST		Replacement Lens, 2" Face, Twist On

Stainless Steel Gauges

These stainless steel gauges with their rugged construction provide resistance to the most corrosive media and environments. The gauges feature 316 stainless steel wetted parts and 304 stainless steel case and crimped ring, and can be liquid-filled in the field.



Standard Ranges / PSI & Part # – Gauge Stainless Steel

Press. Scale / PSI	Part #	Description
30"-0-30 psi	PG-SS3030	Lower Mount – 30"-0-30 psi
30"-0-60 psi	PG-SS3060	Lower Mount – 30"-0-60 psi
15 psi	PG-SS15	Lower Mount – 15 psi
30 psi	PG-SS30	Lower Mount – 30 psi
60 psi	PG-SS60	Lower Mount – 60 psi
100 psi	PG-SS100	Lower Mount – 100 psi
200 psi	PG-SS200	Lower Mount – 200 psi
400 psi	PG-SS400	Lower Mount – 400 psi
600 psi	PG-SS600	Lower Mount – 600 psi
1000 psi	PG-SS1000	Lower Mount – 1000 psi
2000 psi	PG-SS2000	Lower Mount – 2000 psi
3000 psi	PG-SS3000	Lower Mount – 3000 psi
5000 psi	PG-SS5000	Lower Mount – 5000 psi
10000 psi	PG-SS10000	Lower Mount – 10000 psi

Steel – Painted Gauges

These Gauges have a Painted Steel Case and are 1/4" Male NPT with Lower Mount and Dual Scale Dial.



Part # PGSP-LM60

Call for Information on Nitrile Latex-Free Gloves

1 1/2" Diameter Gauge, Painted Steel

Part #	PSI Range
PGSP-LM30R15	0-30 PSI with Red Line
PGSP-LM10015-GR	0-100 PSI – Green Case
PGSP-LM20015-GR	0-200 PSI – Green Case
PGSP-LM40015-RD	0-400 PSI – Red Case
PGSP-LM400015-GR	0-4000 PSI – Green Case



Part # PGSP-LM10015-GR



Part # PGSP-LM40015-RD

Brass – Dual Scale Gauges

These Gauges have a Brass Case and are 1/4" Male NPT with lower mount, dual scale.

2" Diameter Dual Scale Gauge

Part #	PSI Range
PG-LM30R	0-30 PSI w/ Red Line
PG-LM100	0-100 PSI
PG-LM200	0-200 PSI
PG-LM400	0-400 PSI
PG-LM600	0-600 PSI
PG-LM3000	0-3000 PSI
PG-LM4000	0-4000 PSI



Part # PG-LM400

2 1/2" Diameter Dual Scale Gauge

Part #	PSI Range
PG-LM3025R	0-30 PSI w/ Red Line
PG-LM10025	0-100 PSI
PG-LM20025	0-200 PSI
PG-LM40025	0-400 PSI
PG-LM60025	0-600 PSI
PG-LM300025	0-3000 PSI
PG-LM400025	0-4000 PSI
PG-LM600025	0-6000 PSI



Part # PG-LM40025

Brass – Single Scale Gauges

These Gauges have a Brass Case and are 1/4" Male NPT with lower mount, single scale.



2" Diameter Single Scale Gauge

Part #	PSI Range
PG-LMS30R	0-30 PSI with Red Line
PG-LMS100	0-100 PSI
PG-LMS200	0-200 PSI
PG-LMS400	0-400 PSI
PG-LMS4000	0-4000 PSI

2 1/2" Diameter Single Scale Gauge

Part #	PSI Range
PG-LMS3025R	0-30 PSI with Red Line
PG-LMS10025	0-100 PSI
PG-LMS20025	0-200 PSI
PG-LMS40025	0-400 PSI
PG-LMS60025	0-600 PSI
PG-LMS400025	0-4000 PSI

- Stainless Steel Wetted Parts
- Stainless Steel Case & Crimp Ring
- Field Liquid-Fillable
- Welded Connection on 2 1/2" Size
- Cleaned for Oxygen Service



WARNING: Products in this catalog can expose you to chemicals including lead which is known to the State of California to cause cancer, birth defects or reproductive harm. For more information, go to <https://www.p65warnings.ca.gov>

TAMPER EVIDENT SOLUTIONS FOR BEVERAGE CO2



Beverage Grade CO2 Valve Wrap – Imprint White Material

Pt # SW-CO2-BG-PK200



Food Grade CO2 Valve Wrap – Imprint White Material

Pt # SW-CO2-FG-PK200



TAMPER EVIDENT CGA-320 DUST COVER



Tightening the strap down

Breaking tamper evident seal – removing dust cover

Tamper Evident CGA-320 Dust Cover

Part #	Description
HP-WQP320PK100	Tamper Evident CGA-320 Dust Cover, Red - Pack of 100
HP-WQP320PK1000	Tamper Evident CGA-320 Dust Cover, Red - Pack of 1,000

CARBON DIOXIDE Cryogenic Bulk Hose Fittings for Carbon Dioxide

Carbon Dioxide Hose End Assembly

Part Number	Size
BHEA-CO2-100	1"
BHEA-CO2-150	1 1/2"
BHEA-CO2-200	2"

Complete Unit Includes:

- 1 Dust Plug Assembly
- 2 Head Piece
- 3 Nut

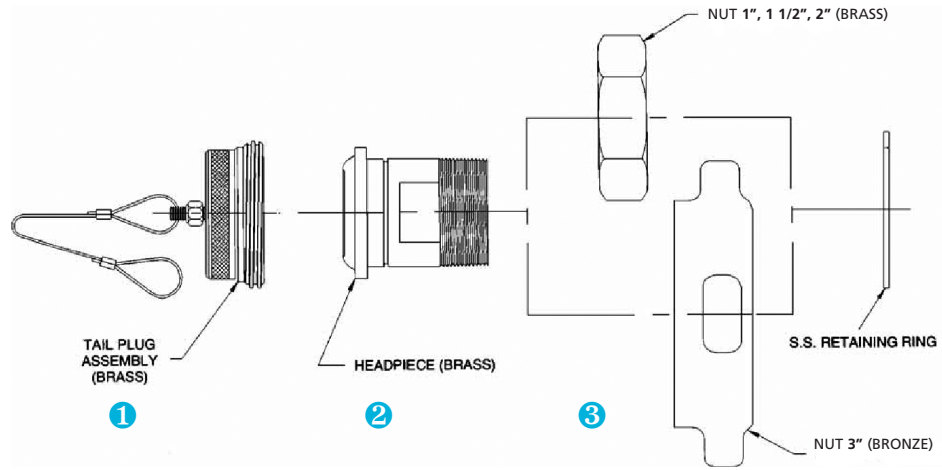

1 Tail Dust Plug Assembly CO2 Brass

Material
Brass Bar per ASTM-B16, with
Stainless Steel Safety Cable

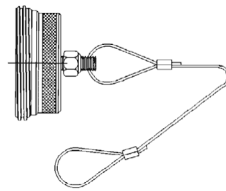

Part Number	Size
BH-DP-100-CO2	1"
BH-DP-150-CO2	1 1/2"
BH-DP-200-CO2	2"
BH-DP-300-CO2	3"

2 Head Piece Carbon Dioxide (Brass)

Materials
Forged Brass per ASTM B283 for 1" and 1 1/2" sizes
Brass Bar per ASTM B16 for 2", 3" and 4" sizes

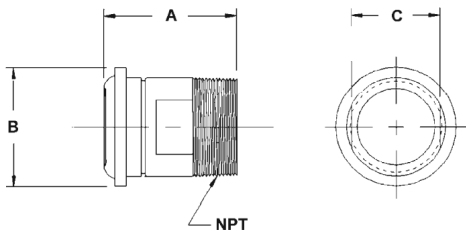

Part Number	Size	NPT	A		B		Wrench-Flats C	
			Inches	MM	Inches	MM	Inches	MM
HPT-CO2-100	1"	1-11 1/2	2.625	66.7	1.500	38.1	1.187	30.1
HPT-CO2-150	1 1/2"	1 1/2-11 1/2	2.750	69.9	2.085	53.0	1.687	42.8
HPT-CO2-200	2"	2-11 1/2	3.156	80.2	2.875	73.0	2.125	54.0
HPT-CO2-300	3"	3-8	4.187	106.3	4.250	108.0	3.250	82.6

3 1", 1 1/2", and 2" Hose Nut Carbon Dioxide (Brass)

Material
Brass Bar per ASTM B16

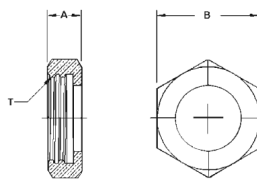

Part Number	Size	"T" Thread Size	A		Hex B		Materials
			Inches	MM	Inches	MM	
BHN-CO2-100	1"	1 11/16-6 Acme	1.10	28.0	2 1/4	57.2	Brass
BHN-CO2-150	1 1/2"	2 1/4-6 Acme	1.10	28.0	2 3/4	69.9	Brass
BHN-CO2-200	2"	3 3/16-6 Acme	1.25	31.8	3 3/4	95.3	Brass
BHN-CO2-100L	1"	1 11/16-6 Acme	1.10	28.0	2 3/4	69.9	Brass

3" Hose Nut Carbon Dioxide (Cast High Strength Magnesium Bronze)

Material
Cast High Strength
Magnesium Bronze per
ASTM B584

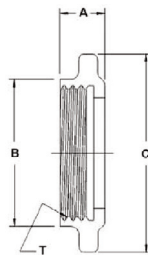

Part Number	Size	"T" Thread Size	A		B		C	
			Inches	MM	Inches	MM	Inches	MM
BHN-CO2-300-HS	3"	4 1/2-6 Acme	1.50	38.1	5	127.0	6.75	171.5

Retaining Rings for Hose End Assemblies

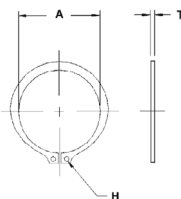

Part Number	Size	A		T		H		Material
		Inches	MM	Inches	MM	Inches	MM	
BHRR-100	1"	1.214	30.84	.050	1.27	.078	1.98	Stainless Steel
BHRR-150	1 1/2"	1.819	46.20	.062	1.57	.125	3.18	Stainless Steel
BHRR-200	2"	2.197	55.80	.078	1.98	.125	3.18	Stainless Steel
BHRR-300	3"	3.552	90.22	.120	3.048	.187	4.75	Zinc Plated Steel

CARBON DIOXIDE Cryogenic Bulk Hose Fittings for Carbon Dioxide

Carbon Dioxide Hose End Assembly with O-Ring

Part Number	Size
BHEOA-CO2-200	2"
BHEOA-CO2-300	3"

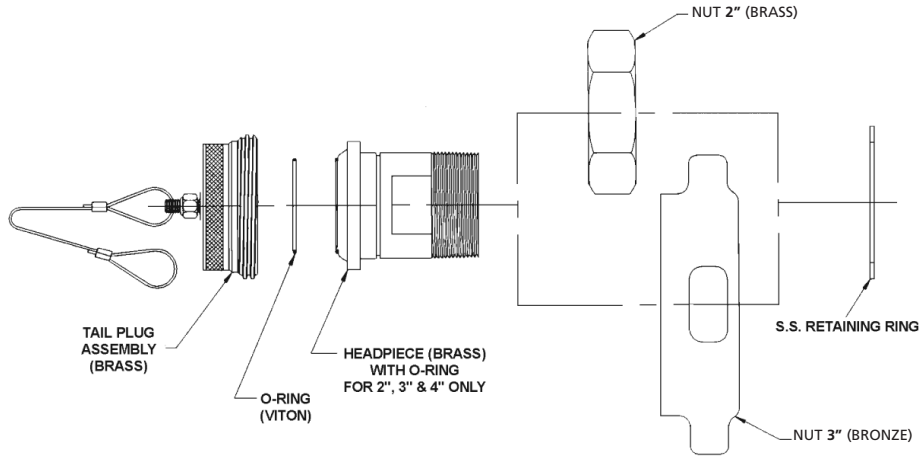

Tail Dust Plug Assembly CO2 Brass

Material
Brass Bar per ASTM-B16, with
Stainless Steel Safety Cable

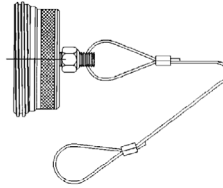

Part Number	Size
BH-DP-200-CO2	2"
BH-DP-300-CO2	3"

O-Ring for Head Piece with O-Ring Option (Viton)

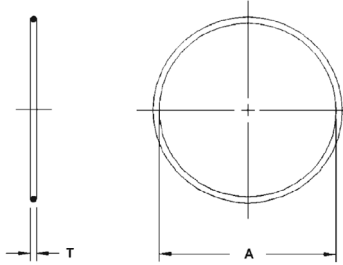

Part Number	Size	A		T	
		Inches	MM	Inches	MM
HPT-OR200	2"	1.989	50.52	.063	1.78
HPT-OR300	3"	2.987	75.87	.094	2.62

Head Piece Carbon Dioxide with O-Ring Groove

Materials
Brass Bar per ASTM B16

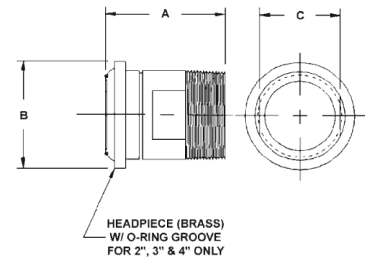

Part Number	Size	NPT	A		B		C	
			Inches	MM	Inches	MM	Inches	MM
HPTO-CO2-200	2"	2-11 1/2	3.156	80.2	2.875	73.0	2.125	54.0
HPTO-CO2-300	3"	3-8	4.187	106.3	4.250	108.0	3.250	82.6

2" Hose Nut Carbon Dioxide (Brass)

Material
Brass Bar per ASTM B16

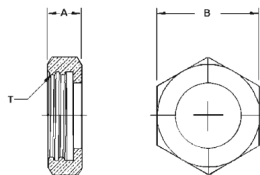

Part Number	Size	"T" Thread Size	A		Hex B		Materials
			Inches	MM	Inches	MM	
BHN-CO2-200	2"	3 3/16-6 Acme	1.25	31.8	3 3/4	95.3	Brass

3" Hose Nut Carbon Dioxide (Cast High Strength Magnesium Bronze)

Material
Cast High Strength
Magnesium Bronze per
ASTM B584

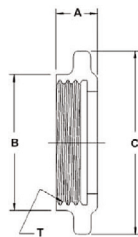

Part Number	Size	"T" Thread Size	A		B		C	
			Inches	MM	Inches	MM	Inches	MM
BHN-CO2-300-HS	3"	4 1/2-6 Acme	1.50	38.1	5	127.0	6.75	171.5

Retaining Rings for Hose End Assemblies

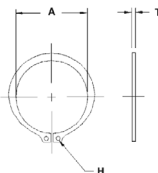

Part Number	Size	A		T		H		Material
		Inches	MM	Inches	MM	Inches	MM	
BHRR-200	2"	2.197	55.80	.078	1.98	.125	3.18	Stainless Steel
BHRR-300	3"	3.552	90.22	.120	3.048	.187	4.75	Zinc Plated Steel

CARBON DIOXIDE Cryogenic Bulk Hose Fittings for Carbon Dioxide

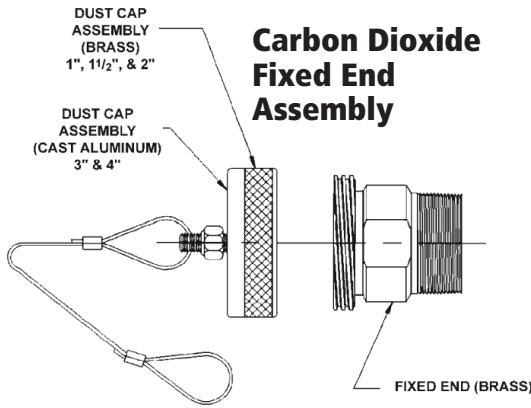

Part Number	Size	Dust-Cap Material
FEA-CO2-100	1"	Brass
FEA-CO2-150	1 1/2"	Brass
FEA-CO2-200	2"	Brass
FEA-CO2-300	3"	Cast Aluminum

Carbon Dioxide Fixed End Brass

Materials
 Forged Brass per ASTM B283 for 1" and 1 1/2" sizes
 Brass Bar per ASTM B16 for 2", 3" and 4" sizes

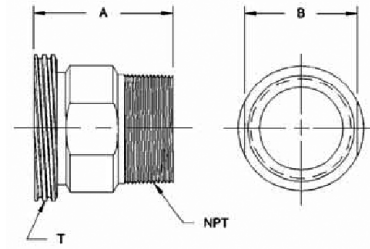

Part Number	Size	NPT	"T" Thread-Size	A		Wrench-Flats B	
				Inches	MM	Inches	MM
FE-CO2-100	1"	1-11 1/2	1.687-6 Acme	2.500	63.5	1.375	34.9
FE-CO2-150	1 1/2"	1 1/2-11 1/2	2.250-6 Acme	2.500	63.5	2.000	50.8
FE-CO2-200	2"	2-11 1/2	3.187-6 Acme	3.000	76.2	2.500	63.5
FE-CO2-300	3"	3-8	4.500-6 Acme	4.062	103.2	3.625	92.1

Carbon Dioxide Dust Cap Assembly

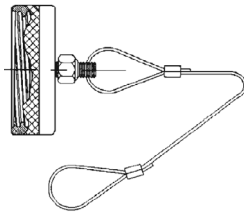

Materials

Brass Bar per ASTM B16, with Stainless Steel Safety Cable for 1", 1 1/2" and 2" sizes
 Aluminum Bar per ASTM B-221, with Stainless Steel Safety Cable for 3" and 4" sizes

Part Number	Size	Material
BH-DCA-100-CO2	1"	Brass
BH-DCA-150-CO2	1 1/2"	Brass
BH-DCA-200-CO2	2"	Brass
BH-DCA-300-CO2	3"	Aluminum

Carbon Dioxide Fixed End Assembly with 1/2" FNPT Purge Ports

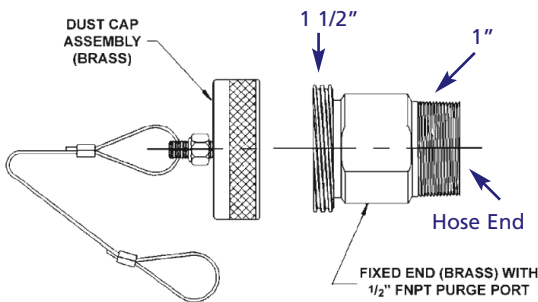

Part Number	Size	Dust-Cap Material
FEPPA-CO2-100	1"	Brass
FEPPA-CO2-150	1 1/2"	Brass

Carbon Dioxide Fixed End with 1/2" FNPT Purge Ports (Brass)

Materials
 Brass Bar per ASTM B16

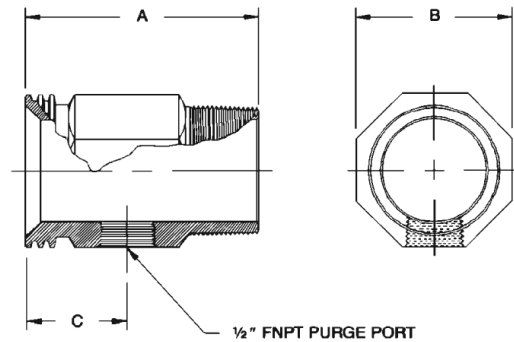

Part Number	Size	NPT	"T" Thread Size	A		Wrench-Flats B			
				Inches	MM	Inches	MM	Inches	MM
FEPP-CO2-100	1"	1-11 1/2	1.687-6 Acme	4	101.6	1 3/4	44.5	2 7/16	61.9
FEPP-CO2-150	1 1/2"	1 1/2-11 1/2	2.250-6 Acme	4	101.6	2 3/8	60.3	2 7/16	61.9

Carbon Dioxide Dust Cap Assembly

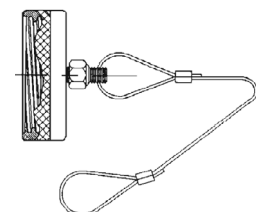

Materials

Brass Bar per ASTM B16, with Stainless Steel Safety Cable for 1" and 1 1/2" sizes

Part Number	Size	Material
BH-DCA-100-CO2	1"	Brass
BH-DCA-150-CO2	1 1/2"	Brass

CARBON DIOXIDE Cryogenic Bulk Hose Fittings for Carbon Dioxide

Male to Male Adapter to Connect Two or More Lengths of Hoses (Brass)

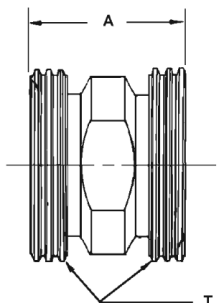

Material – Brass per ASTM B16

Part Number	Size	A		"T" Thread-Size	Wrench-Flats	
		Inches	MM		Inches	MM
BMA-100-CO2	1"	3.375	85.7	1.687-6 Acme	1.375	34.9
BMA-150-CO2	1 1/2"	3.375	85.7	2.250-6 Acme	2.000	50.8
BMA-200-CO2	2"	3.375	85.7	3.187-6 Acme	2.500	63.5
BMA-300-CO2	3"	3.375	85.7	4.500-6 Acme	3.625	92.1
BMA-150/200-CO2	2"-1 1/2"	3.375	85.7	3.187-6 Acme 2.250-6 Acme	2.500	63.5
BMA-100/150-CO2	1 1/2"-1"	3.375	85.7	2.250-6 Acme 1.687-6 Acme	2.000	50.8

Open End Wrenches (Aluminum Anodized)

Material – Cast Aluminum per ASTM B26

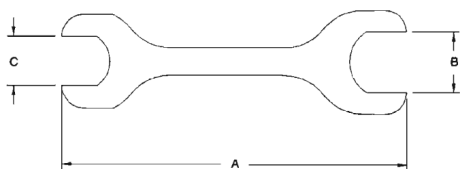

Part Number	Fits	A		B		C	
		Inches	MM	Inches	MM	Inches	MM
BFAW-100/150-NUT	1" & 1 1/2" Nut	16	406.4	2 3/4	69.9	2 1/4	57.2
BFAW-100/150-FXE	1" & 1 1/2" FE*	16	406.4	1 3/8	34.9	2	50.8
BFAW-100/200-FXE	1" & 2" FE*	16	406.4	1 3/8	34.9	2 1/2	63.5
BFAW-100/200-NUT	1" & 2" Nut	20	508.0	2 1/4	57.2	3 3/4	95.3
BFAW-200NUT200FXE	2" Nut / 2" FE*	20	508.0	3 3/4	95.3	2 1/2	63.5
BFAW-150/200-NUT	1 1/2" & 2" Nut	20	508.0	3 3/4	95.3	2 3/4	69.9

* FE = Fixed End

Full Coupling to Adapt NPT Male Hoses (304 Stainless Steel)

Material – Type 304 Stainless Steel per ASTM A276

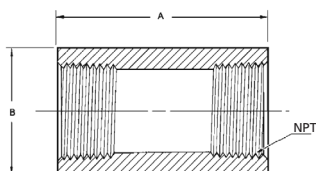

Part Number	Hose Size	NPT	A		B	
			Inches	MM	Inches	MM
BFC-F1	1"	1-11 1/2	1.937	49.2	1.562	39.7
BFC-F12	1 1/2"	1 1/2-11 1/2	2.125	54.0	2.188	55.6
BFC-F2	2"	2-11 1/2	2.50	63.5	2.75	69.9

Reducing Couplings to Adapt NPT Male Hoses (304 Stainless Steel)

Material – Type 304 Stainless Steel per ASTM A276

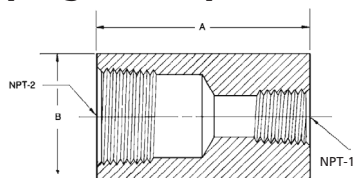

Part Number	Hose Size	NPT 1	NPT 2	A		B	
				Inches	MM	Inches	MM
BRC-F1F112	1 1/2"	1-11 1/2	1 1/2-11 1/2	2.125	54.0	2.188	55.6
BRC-F12F2	2"	1 1/2-11 1/2	2-11 1/2	2.50	63.5	2.75	69.9

Hex Brass Coupling to Adapt Tanks for Fixed End Material – Brass per ASTM B16

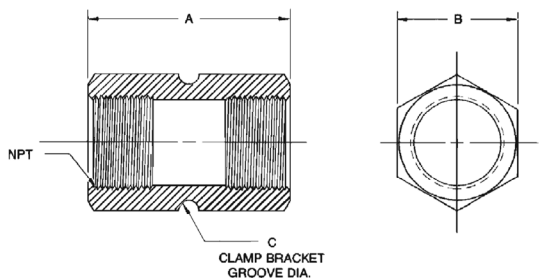

Part Number	Hose Size	NPT	A		B		C	
			Inches	MM	Inches	MM	Inches	MM
BCH-F1	1"	1-11 1/2	2.50	63.5	1.75 Hex	44.5	1.72	43.7
BCH-F112	1 1/2"	1 1/2-11 1/2	2.50	63.5	2.50 Hex	63.5	2.47	62.7
BCH-F2	2"	2-11 1/2	2.50	63.5	3.00 Hex	76.2	2.97	73.7

Hex Brass Bushing with 3 Purge Ports to Adapt Trailers for Fixed End

Material – Brass per ASTM B16 shipped complete with two 1/2" Brass Pipe Plugs

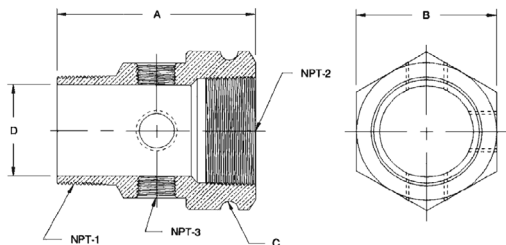

Pt Number	Size	NPT			A		B		C		D	
		1	2	3	Inches	MM	Inches	MM	Inches	MM		
BCH-PP-F112M112	1 1/2"	1 1/2-11 1/2	1 1/2-11 1/2	1/2-14	4.250	107.9	2.500*	63.5	2.47	62.7	1.50	38.1
BCH-PP-F2M112	2"	2-11 1/2	1 1/2-11 1/2	1/2-14	4.250	107.9	2.500*	63.5	2.47	62.7	1.50	38.1
BCH-PP-F2M2	2"	2-11 1/2	2-11 1/2	1/2-14	4.250	107.9	3.000*	76.2	2.97	73.7	2.00	50.8

CO2 CYLINDERS Aluminum Cylinders Painting & Stamping

Carbon Dioxide Specifications

- Service Pressure:** 1800psi/124bar
- Specification:** DOT-3AL & TC-3ALM designed ISO design cylinders are available
- Alloy:** Manufactured from high strength aluminum alloy 6061-T6
- Threads:** 5LB & larger supplied with 1.125-12 UNF thread, all others with .750-16 UNF thread
Other thread sizes available upon request
- Markings:** As required by specification, inclusive of tare weight
Additional markings available upon request
- Finish:** Standard finish is brushed body with unpainted crown
- Graphics:** Logos or labels in silkscreen or Duragrafix available upon request

IDEAL FOR
DISPENSING
CARBONATED
SOFT DRINKS,
BEERS, LAGERS
AND OTHER
BEVERAGES.



NOTE: Cylinders have D.O.T. approval to be filled with several gases including NITROGEN, BLENDED GAS, etc. Check with your local filler or welding supply. Fillable up to 1800 PSI

CO2 Cylinders – Aluminum 1800 PSI Working Pressure

PART #	WATER CAPACITY			DIAMETER		LENGTH		CYLINDER WEIGHT		CO2		NITROGEN
	cu in	lbs	liters	in	mm	in	mm	lbs	kgs	lbs	kgs	cu ft
CYL-CO2-2LB	83.0	3.0	1.40	4.38	111.3	8.5	213	2.9	1.3	2.0	0.9	5.9
CYL-CO2-2.5LB	102	3.7	1.70	4.38	111.3	10.3	262	3.3	1.5	2.5	1.1	7.2
CYL-CO2-5LB	203	7.4	3.40	5.25	133.4	14.2	361	6.3	2.9	5.0	2.3	14.5
CYL-CO2-10LB-H	407	14.7	6.70	6.89	175.0	16.5	419	12.6	5.7	10.0	4.5	29.0
CYL-CO2-15LB-H	612	22.1	10.0	6.89	175.0	23.1	587	16.8	7.6	15.0	6.8	43.3
CYL-CO2-20LB-H	814	29.4	13.3	8.00	203.2	23.2	589	23.7	10.8	20.0	9.1	57.6
CYL-CO2-22LB-H	901	32.5	14.7	8.00	203.2	25.1	638	25.3	11.5	22.0	10.0	63.5
CYL-CO2-35LB-H	1426	51.5	23.4	8.00	203.2	37.8	960	35.2	16.0	35.0	15.9	100.9
CYL-CO2-50LB-H	2035	73.5	33.3	8.60	218.4	46.3	1175	48.3	21.9	50.0	22.7	144.0

10 LB thru 50 LB come with Carry Handles.

WARNING: Cancer and Reproductive Harm – www.P65Warnings.ca.gov

Cylinder Painting and Stamping for Easy Identification

Call us today to have your cylinders **PAINTED and STAMPED** for easy identification.

- 1 – Choose Your Style & Color
- 2 – Choose Your Stamp – Use any combination of letters and numbers



Aluminum Industrial Cylinders

Preferred cylinder package for specialty gas, exotic gas and high-purity gas mixtures.

Features

- Lightweight, high strength 6061-T6 alloy
- Corrosion-resistant interior and exterior
- Stringent internal cleaning process ensures compliance with customer specifications
- Available with straight or tapered threads
- Uses Industrial CGA540, 580 or comparable valve, sold separately
- Wide color range available, including a durable, brushed exterior finish

Manufactured to DOT and TC requirements

- U.S. Department of Transportation (DOT) 3AL
- Transport Canada (TC) 3ALM
- Every cylinder inspected and tested by DOT- and TC-authorized independent agency
- Cycle-tested in excess of 100,000 cycles at service pressure
- Minimum burst pressure tested to 2.5 times service pressure without failure



Note:
Cylinder colors may vary from photo.

Industrial and Specialty Gas Cylinders – Aluminum

PART #	Service Pressure		Water Capacity		Diameter		Length		Cylinder Weight		Oxygen		Nitrogen
	PSI	BAR	LBS	LITERS	IN	MM	IN	MM	LBS	KGS	LBS	KGS	CU. FT.
CYL-I4	2216	153	1.5	0.7	3.21	81.5	8.7	221	1.7	0.8	4.0	113	3.7
CYL-I6	2216	153	2.3	1.0	3.21	81.5	11.8	300	2.3	1.0	6.0	170	5.6
CYL-I22	2216	153	8.5	3.9	5.25	133.4	16.3	414	8.2	3.7	22.0	623	20.4
CYL-I24	2015	139	10.2	4.6	4.38	111.3	25.4	645	7.8	3.5	24.0	680	22.0
CYL-I33	2216	153	13.0	5.9	6.89	175.0	15.3	388	13.8	6.3	33.7	954	31.2
CYL-I48	2216	153	18.6	8.4	5.25	133.4	32.2	818	15.2	6.9	48.2	1365	44.6
CYL-I60	2216	153	23.2	10.5	7.25	184.2	22.9	582	22.3	10.1	60.0	1699	55.4
CYL-I90	2216	153	34.7	15.7	7.25	184.2	32.6	828	30.4	13.7	90.0	2549	82.9
CYL-I122	2216	153	47.1	21.4	8.00	203.2	36.2	919	40.3	17.9	122.0	3455	113.0
CYL-I20L	2900	200	44.1	20.0	8.00	203.2	36.9	937	49.5	22.5	149.0	4219	137.0
CYL-I150	2015	139	63.7	28.9	8.00	203.2	47.2	1198	49.2	22.3	150.0	4248	138.8
CYL-I265	2216	153	102.2	46.4	9.80	248.9	51.7	1313	84.7	38.4	265.0	7503	245.0

WARNING: Products in this catalog can expose you to chemicals including Lead which is known to the State of California to cause cancer, birth defects or reproductive harm. For more information, go to <https://www.p65warnings.ca.gov>

20 lb. Cylinder Storage / Transportation Racks

FEATURES:

- Meets DOT Regulations for safe and efficient storage and transportation of compressed gases when used with E-Track Strap
- Rigid welded frames construction
- Racks are forkliftable from front or side and are stackable
- E-Track Sides to use with Logistics E-Track Straps

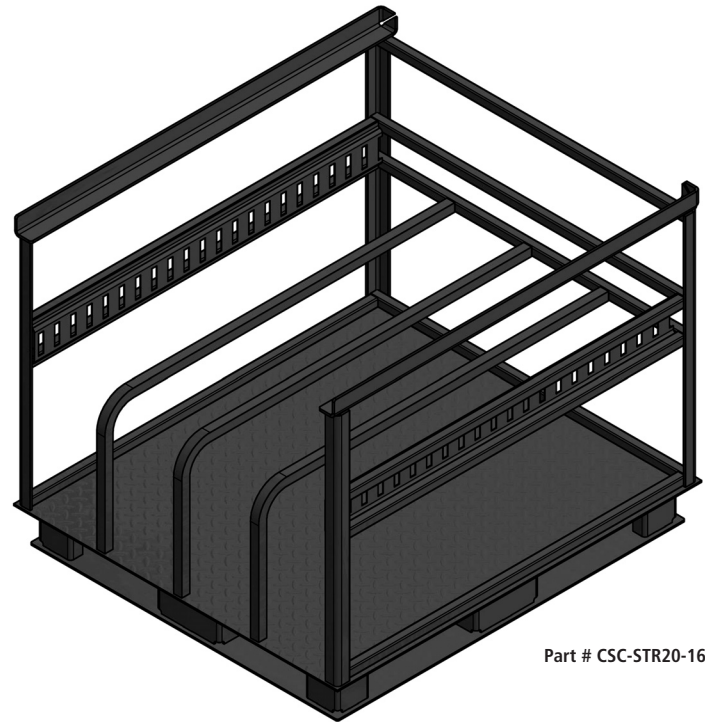

Part # CSC-STR20-16

20 lb. Cylinder Storage / Transportation Racks

Part #	Description	Overall Dimensions	Empty Rack Weight
CSC-STR20-16	16-Cylinder Stackable	36"D x 37"W x 36"H	152 lbs.
TSK-E4-012	E-Track Strap – 4 foot long		

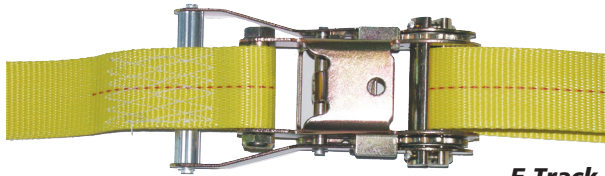

E-Track Strap

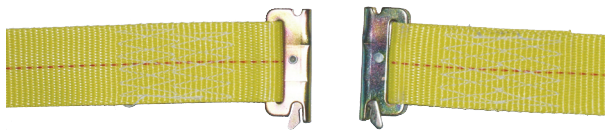

E-Track & E-Track Restraints

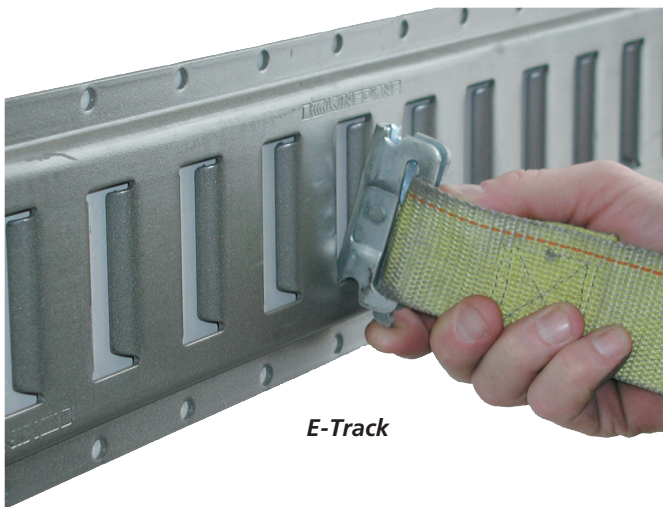

E-Track

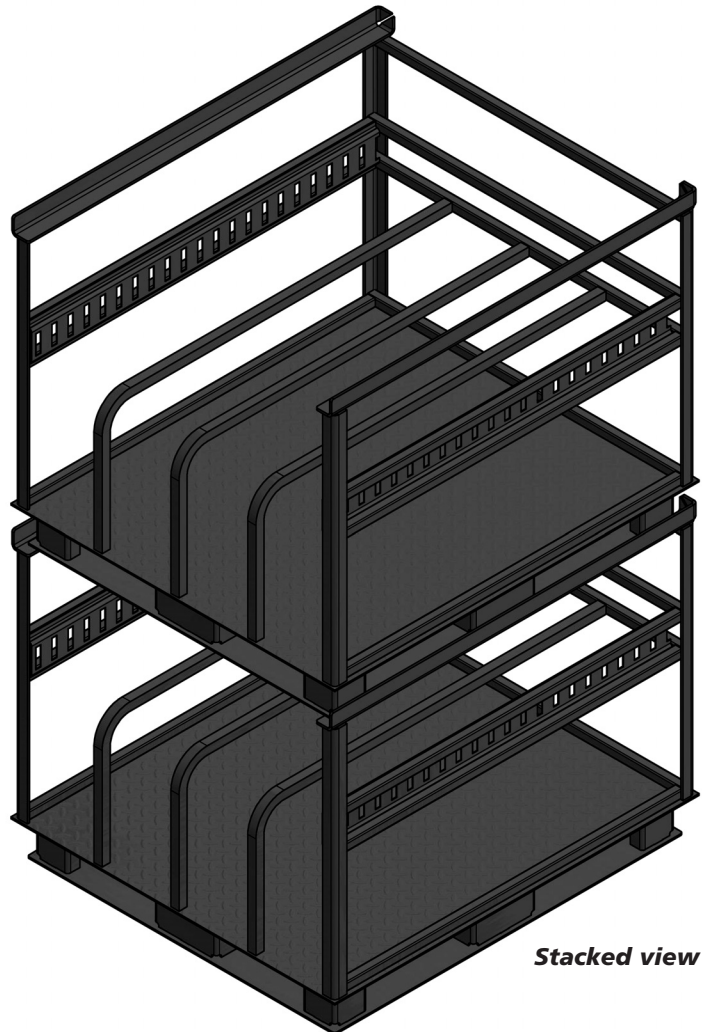

Stacked view

E-Track & E-Track Restraints

Part #	Description
TSK-E12	12' E-Track Strap, Standard
TSK-E20	20' E-Track Strap, Standard

E-Track Sections for Truck Trailers

Part #	Description
TS-ETRACK	10' Sections
TS-ETRACK60	5' Sections
TS-ENDCAP	End Cap

⚠ WARNING: Products in this catalog can expose you to chemicals including Lead which is known to the State of California to cause cancer, birth defects or reproductive harm. For more information, go to <https://www.p65warnings.ca.gov>

Standard Surface Mount Fill Box



Complete with CO2 Fill Nipple, 3/8" vent elbow and lockable catch or turnkey thumb lock.

Part Number	Connection
FB-SUR-58	5/8" Flare
FB-SUR-12	1/2" FPT
FB-SUR-34	3/4" FPT

CO2 Fill Box Overview

- Durable 16 Gauge 304 Stainless Steel Construction
- Surface or Flush (recessed) Mount Fill Boxes
- Extension Boxes for Fill Lines Installed on Exterior Building Walls
- Field Replaceable CO2 Fill Plates
- Lockable or Keyless Fill Box Closures
- Available CO2 Nipples:
 - 5/8" Flare x Liquid CO2 Fill Nipple
 - 1/2" FPT x Liquid CO2 Fill Nipple
 - 3/4" FPT x Liquid CO2 Fill Nipple

"Classic" Flush Mount Fill Box

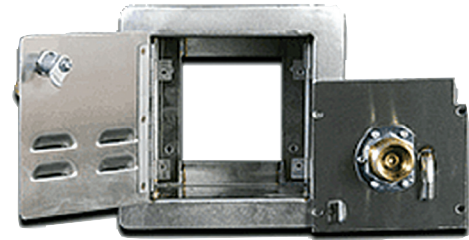

Hidden from view, this recessed fill box makes for an architecturally pleasing installation, while allowing easy access for fill and maintenance.

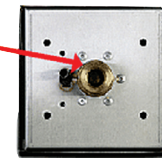

Part Number	Connection
FB-FLS-58	5/8" Flare
FB-FLS-12	1/2" FPT
FB-FLS-34	3/4" FPT

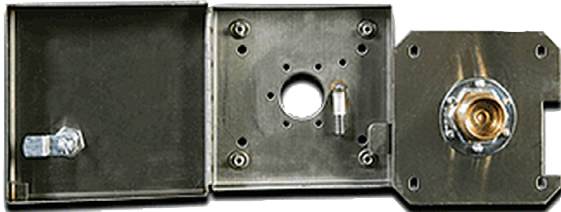

Standard Surface Mount Fill Box with Removable Plate

The removable plate makes for an easier installation or quick CO2 Fill Nipple replacement.

Part Number	Connection
FB-SUR-RP-58	5/8" Flare
FB-SUR-RP-12	1/2" FPT

Keyless Standard Surface Mount Fill Box

Our integrated keyless closure system reduces unnecessary service calls due to an open fill box.



Part Number	Connection
FB-SURKL-58	5/8" Flare
FB-SURKL-12	1/2" FPT
FB-SURKL-34	3/4" FPT

Flush Mount Conversion Plate

This stainless steel plate is used to convert a "Classic" Flush Mount to a Standard Surface Mount Fill Box installation (*fill box sold separately*).

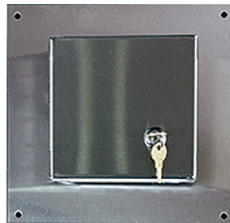

Surface Mount Cover Plate NOT SHOWN

A stainless steel plate that covers the opening left by a Standard Surface Mount Fill Box that has been removed.

Part Number	Description
FB-FLS-CONPLT	Flush Mount Conversion Plate
FB-SUR-COVPLT	Surface Mount Cover Plate

Standard Surface Mount Fill Box Extension Kit



This fill box combination allows the ability to run the fill and vent lines in any direction along the outer building wall. The kit includes the Standard Surface Mount Fill Box, 1/2" 90° Fitting and mounting screws.

Standard Surface Mount Fill Box Extension Only

Compatible with the Standard Surface Mount Fill Box (*Part # FB-SUR-12 sold separately*). The 1/2" 90° Fitting and mounting screws are included.



Part Number	Description
FB-EKKIT-SUR-12	Standard Surface Mount Fill Box Extension Kit
FB-EX-SUR	Standard Surface Mount Fill Box Extension Only

WARNING: Products in this catalog can expose you to chemicals including Lead which is known to the State of California to cause cancer, birth defects or reproductive harm. For more information, go to <https://www.p65warnings.ca.gov>

Dry Ice Poly Boxes

Dry Ice Poly Boxes

Dry ice poly boxes provide a wide variety of USDA approved insulated dry ice storage boxes for use with dry ice pellets, discs, slices or blocks. Our line of high-quality polyethylene storage containers are designed specifically for holding and transporting items that require dry ice or wet ice. The boxes are built to withstand the extreme cold temperatures of dry ice while retaining the durability needed for everyday operation.



FEATURES

- Made of double-wall polyethylene that is filled with urethane foam insulation
- Virtually unbreakable in daily operations
- Lightweight and durable for easy mobility
- Maintains critical temperatures for your laboratory specific materials
- Ideal for CO2 cleaning, frozen food, medical & laboratory applications
- Casters are available for easy maneuverability
- Hinged lids with latches
- Available with or without drains
- Optional casters available on some models



Part # TM-TSP-11
sold with or without casters

Part #	External Dimensions	Internal Dimensions	Approximate Empty Weight	Dry Ice Block	Volume	Dry Ice Pellet Capacity
TM-TSP-11	40" x 28" x 43"	35.5" x 21" x 24"	110 lbs.	12 Blocks	11 CF	520 lbs.
	101.6 x 71.12 x 109.22 cm	90.17 x 53.34 x 60.96 cm	49.9 kg		.320 m ³	
TM-TSP-27	47.5" x 43" x 39.75"	41.5" x 37" x 30"	204 lbs.	36 Blocks	27 CF	1,400 lbs.
	120.65 x 109.22 x 100.97 cm	105.41 x 93.98 x 76.20 cm	92.53 kg		.786 m ³	
TM-TSP-30	47.5" x 43" x 41.5"	41.5" x 37" x 31"	220 lbs.	36 Blocks	30 CF	1,450 lbs.
	120.65 x 109.22 x 109.95 cm	107.95 x 93.98 x 78.74 cm	99.79 kg		.873 m ³	
TM-TSP-34	56.75" x 46.75" x 36"	51" 41" x 28"	200 lbs.	40 Blocks	34 CF	1,800 lbs.
	144.15 x 118.75 x 91.44 cm	129.54 x 104.14 x 71.12 cm	90.72 kg		.9894 m ³	

Remote Oxygen Depletion Safety Alarm MTR-RAD-0002

Series MTR-RAD-0002 Remote Oxygen Depletion Safety Alarm



The MTR-RAD-0002 Remote Oxygen Depletion Safety Alarm is designed to detect oxygen depletion in enclosed spaces and to warn occupants of low oxygen levels. Low concentrations of oxygen (O₂) in confined spaces are dangerous, and may lead to health problems ranging from headaches and fatigue to asphyxiation and death. This monitor has both audible and visual alarms which activate when the O₂ concentration is lower than the pre-set alarm levels. Detection of low levels of O₂ will also activate relays that can be used for a fan or air-handling system to ventilate the confined space and improve O₂ concentration in the area.

The first audible and visual alarms will activate when the oxygen concentration falls below 19.5% per OSHA requirements.

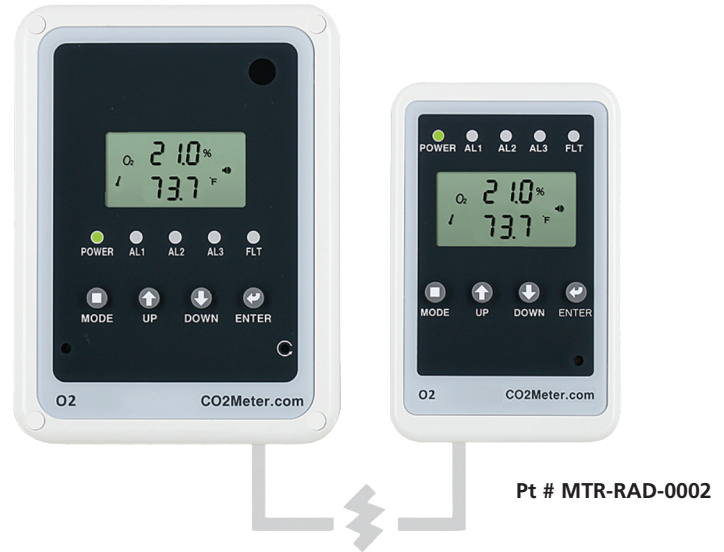

Features

- Large digital LCD display
- Separate SEU (Main Sensor) and RDU (Remote Display)
- 3 Relay outputs to control ventilation devices
- 4-20mA Outputs - O₂: 0~25%, Temp: 32 to 122° F
- Audible and visual indications at 3 alarm levels
- Ability to add strobes for additional indication
- Automatic barometric pressure compensation

Accessories

- CM-1026 I Dual Strobe Add On Kit
- CM-0126-5,6 I Strobe Tower Add On Kit
- RAD-0022I Additional Remote Display

Applications

- Cryogenics
- Cryotherapy
- Food Production Facilities
- Process Cooling
- Any enclosed space storing inert gases

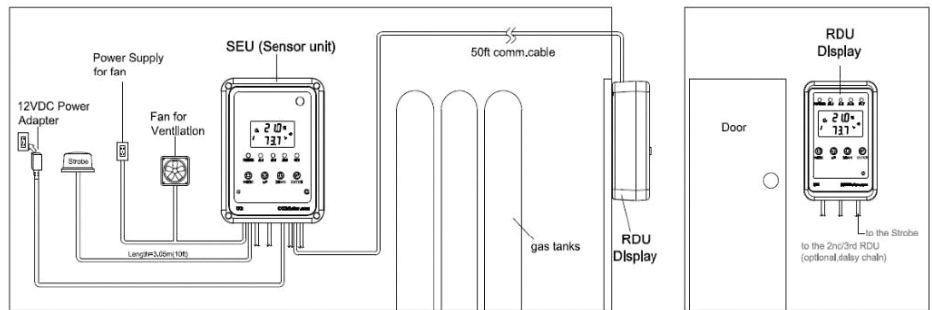

Remote Oxygen Depletion Safety Alarm	
Range	0 - 25% display
Display Resolution	0.1%
Accuracy	Better than 2%FS
Temperature Range	32°F to 122°F (0°C to 50°C)
Response Time	O ₂ : <2min by 90%
O ₂ AL1	18.0%, 18.5%, 19.0%, 19.5%, 20.0%. The default AL1 is 19.0%.
O ₂ AL2	16.0%, 16.5%, 17.0%, 17.5%. The default AL2 is 17.0%
Operating Temperature	32°F to 122°F (0°C to 50°C) For Storage: -4°F to 140°F (-20°C to 60 °C)

Electrical and Mechanical Specifications	
Power Supply	Output: 12VDC, 2000mA.
Power Input	100~240 VAC, 50/60Hz, 0.6A
Power Consumption	6VDC (5.4V~7.0V), recommended capacity is 12AH
Relays	Peak current for each relay < 2A @ 30VDC or 250VAC & Relay configuration: SPDT
4-20mA Outputs	CL01:420mA O ₂ : 0~25% CL02:420mA Temp: 32 to 122° F (0-50°C)
Mounting Height	60-72 inches from floor height
Model	
MTR-RAD-0002	Remote Oxygen Depletion Safety Alarm

⚠ WARNING: Products in this catalog can expose you to chemicals including lead which is known to the State of California to cause cancer, birth defects or reproductive harm. For more information, go to <https://www.p65warnings.ca.gov>

Remote CO2 Storage Safety Three Alarm Monitor MTR-RAD-0102-6



Series MTR-RAD-0102-6 Remote CO2 Storage Safety Three Alarm Monitor

The Remote CO2 Storage Safety Three Alarm Monitor detects carbon dioxide (CO2) levels in ambient air. This protects employees and guests from potentially hazardous gas concentrations. The MTR-RAD-0102-6 features audible and visual alarms that can trigger three individual relays. These relays can trigger third-party devices like exhaust systems and fire panels. Ensure the safety of your employees and guests as well as the compliance of your facility with the CO2 Storage Safety Three Alarm Monitor.

Features

- LCD display clearly indicates current CO2 level in PPM or % and temperature
- 3 alarms/relays
- Relays can automatically control ventilation fans or signal a fire alarm panel
- Meets NFPA, IFC, and NBIC requirements
- Meets OSHA and NIOSH TWA standards
- IP54 Enclosure
- UL listed for compliance

Applications

- Restaurant & Food
- Breweries and Wineries
- Beverage Dispensing
- Agriculture
- Safety

Accessories

- SV-1028 I Valve



Pt # MTR-RAD-1026-6

Remote CO2 Storage Safety Three Alarm Monitor

CO2 Measurement Range	0-5% (0-50,000 ppm)
CO2 Measurement	NDIR (Non-dispersive Infrared)
Alarms	5,000 TWA, 1.5% (user configurable), 3% (user configurable)
Measurement Interval	2 seconds (0.5 Hz)
Operating Temperature	32-122° F (0-50° C)
Calibration	Zero with Nitrogen or Factory Calibration
Connections	Standard RJ45
Sensor Life Expectancy	>15 years

Electrical and Mechanical Specifications

Power Supply	110-220 VAC 50/60 Hz to 12 VDC power adapter
Power Input	4.5-5.25 VDC
Power Consumption	3 Watts
Hard-Wired	24 VDC hard-wired option (cable included)
Output	4-20 mA

Alarms & Relays

Response Time	<60 seconds
Alarm Level	88 dB
Relay Power	Peak current <2A @ 30 VDC or 250 VAC, SPDT
Relay Color Coding	Red & White: Normally Open, Blue & White: Normally Closed

WARNING: Products in this catalog can expose you to chemicals including lead which is known to the State of California to cause cancer, birth defects or reproductive harm. For more information, go to <https://www.p65warnings.ca.gov>

Series MTR-RAD-0102-6 Dual Strobe Add-On Kits

These strobes provide a bright, flashing indicator for any of our CO2 or Oxygen Storage Safety Alarms. These 100 cd strobes clearly indicate the alarm level to anyone in the room.

One strobe connects to the sensor display and one to the remote display via an Ethernet cable (included). No additional wiring is required. Strobes flash when Alarm 1, 2, or 3 is triggered. Does not require an additional power source.



Pt # MTRCM-1026

Features

- Strobes are connected to the main and remote units with standard RJ45 connections instead of them being controlled by the relays
- Controlled by the relay outputs on RAD sensor unit
- Input voltage: 6 to 12VDC
- Heavy duty 18-gauge leads
- Easily connected to all security systems

Specifications

- 6' ft Ethernet cables included
- Alarms:
 - 5,000ppm TWA
 - 1.5% CO2
 - 3% CO2

Applications

- Restaurants
- Breweries
- Agriculture



Scan for all things
RATERMANN